

# Experimental study of Generalised Parton Distributions at Jefferson Lab

**Daria Sokhan**  
University of Glasgow, UK

**The 11th Workshop on Hadron Physics in China and Opportunities Worldwide**  
**Nankai University, Tianjin, China — 24th August 2019**



# **Introduction**

# A constructivist view of the nucleon

Wigner distributions

$$\rho(x, \vec{k}_T, \vec{b}_T)$$

***intuitive relation to  
experimental observables***

Longitudinal momentum

$$k^+ = xP^+$$

$x$ : longitudinal  
momentum  
fraction carried by  
struck parton

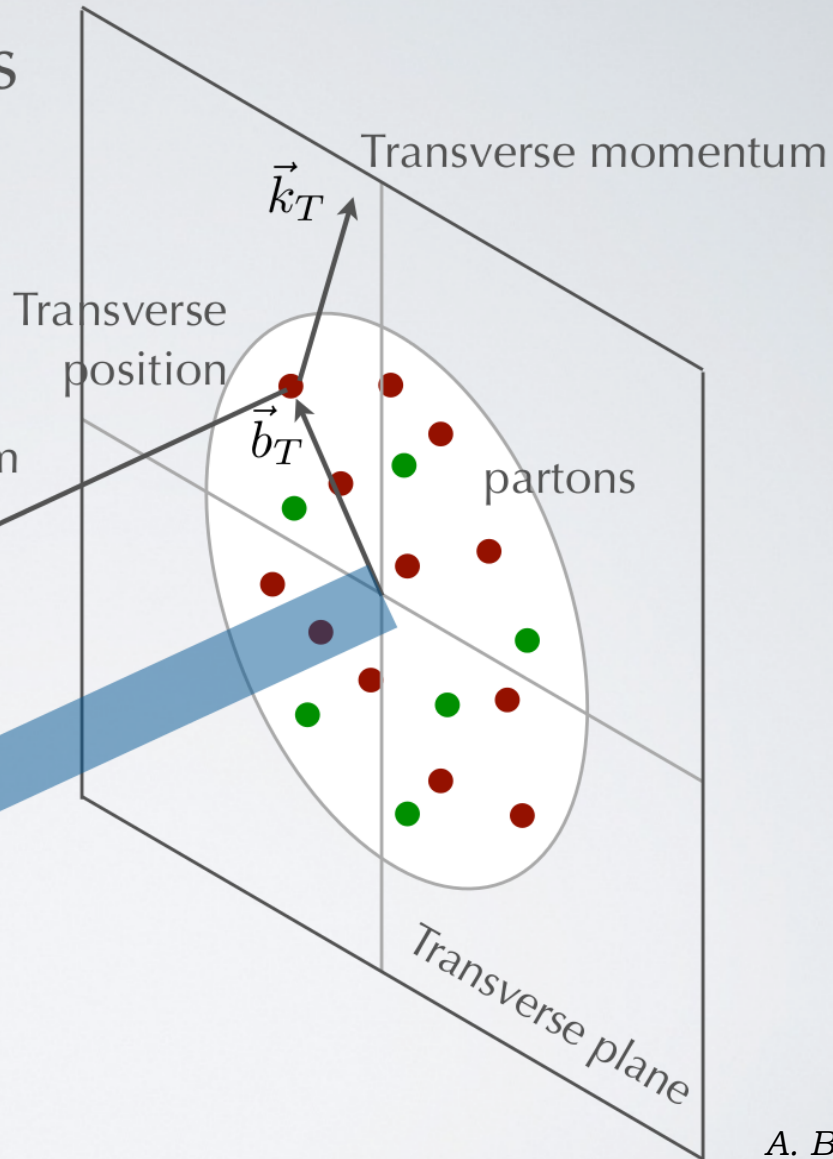

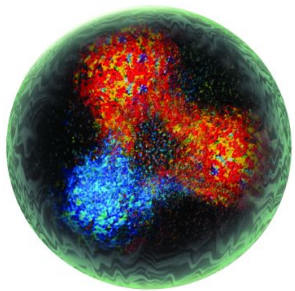

*Wigner function:  
full phase space parton  
distribution of the nucleon*

Generalised Transverse Momentum  
Distributions (GTMDs)

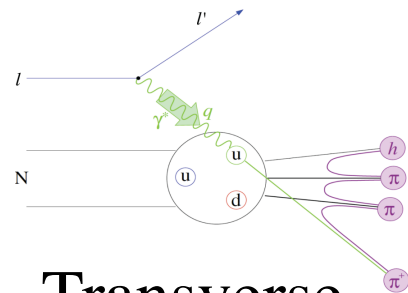

Transverse  
Momentum  
Distributions  
(TMDs)

$$\int d^2 k_T$$

$$\int d^2 b_T$$

Generalised Parton  
Distributions (GPDs)

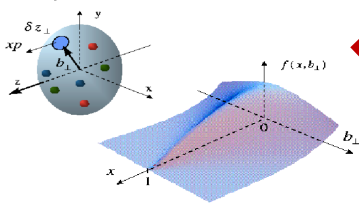

$$\int dx$$

$$\int d^2 b_T$$

$$\int d^2 k_T$$

Form Factors  
*eg:  $G_E, G_M$*

Parton Distribution  
Functions (PDFs)

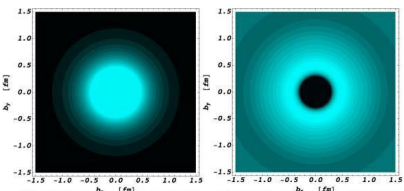
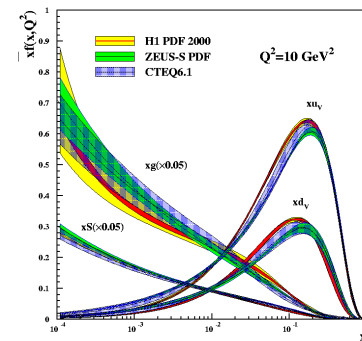

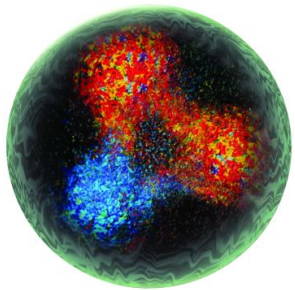

*Wigner function:*  
*full phase space parton*  
*distribution of the nucleon*

Generalised Transverse Momentum  
 Distributions (GTMDs)

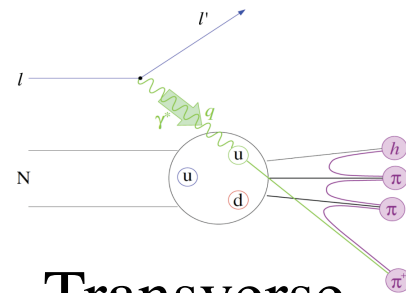

$$\int d^2 k_T$$

$$\int d^2 b_T$$

Generalised Parton  
 Distributions (GPDs)

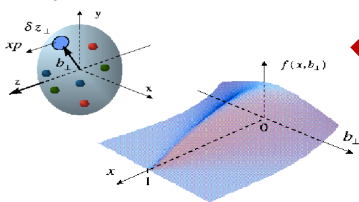

$$\int dx$$

Form Factors  
*eg: G<sub>E</sub>, G<sub>M</sub>*

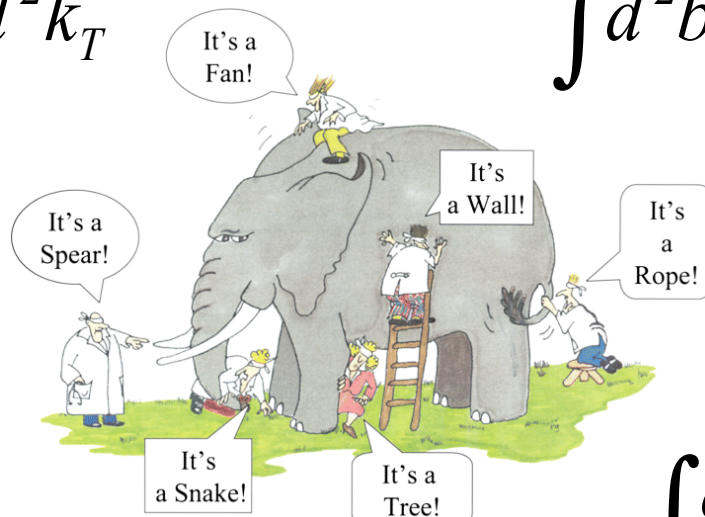
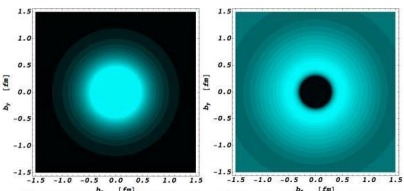

*G. Renee Guzlas, artist.*

Transverse  
 Momentum  
 Distributions  
 (TMDs)

$$\int d^2 k_T$$

Parton Distribution  
 Functions (PDFs)

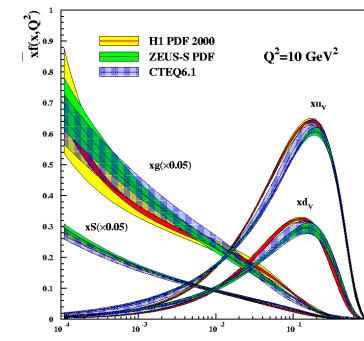

# Generalised Parton Distributions

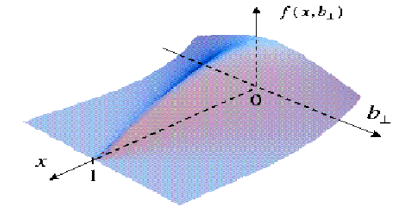
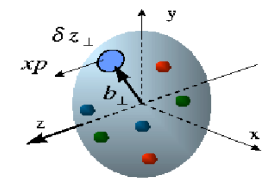

- proposed by Müller (1994), Radyushkin, Ji (1997).
- can be interpreted as relating, in the infinite momentum frame, transverse position of partons (impact parameter  $b_{\perp}$ ) to longitudinal momentum fraction ( $x$ ).

\* **Tomography** of the nucleon: transverse spatial distributions of quarks and gluons in longitudinal momentum space.

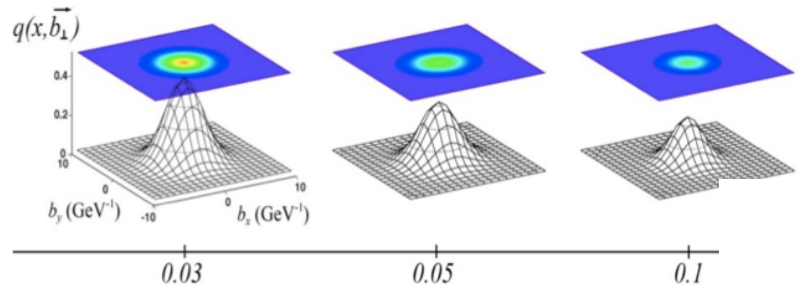

\* Information on the orbital angular momentum contribution to nucleon spin: **the spin puzzle.**

$$J_N = \frac{1}{2} = \frac{1}{2} \sum_q + L_q + J_g$$

*Ji's relation:*

$$J^q = \frac{1}{2} - J^g = \frac{1}{2} \int_{-1}^1 x dx \left\{ H^q(x, \xi, 0) + E^q(x, \xi, 0) \right\}$$

\* Indirect access to mechanical properties of the nucleon: possibilities of extracting **pressure distributions** within the nucleon.

\* Combine with TMDs to access **spin-orbit correlations** of quarks and gluons, study non-perturbative interactions of partons.

# Experimental paths to GPDs in electron - hadron scattering

Accessible in *exclusive* reactions, where all final state particles are determined:



cliparts.co

- \* Deeply Virtual Compton Scattering (DVCS)
- \* Deeply Virtual Meson Production (DVMP) / Hard Exclusive Meson Production (HEMP)
- \* Time-like Compton Scattering (TCS)
- \* Double DVCS
- \* Photon-meson production
- \* ...

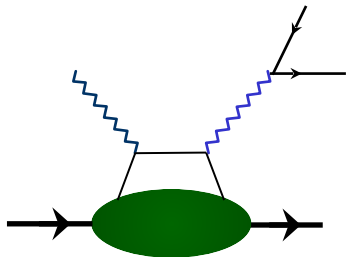

**TCS**

*Virtual photon time-like*

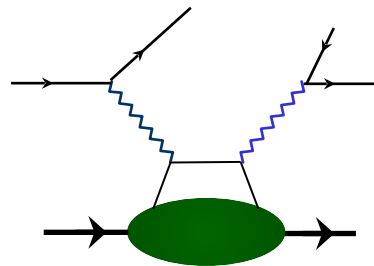

**DDVCS**

*One time-like, one space-like virtual photon*

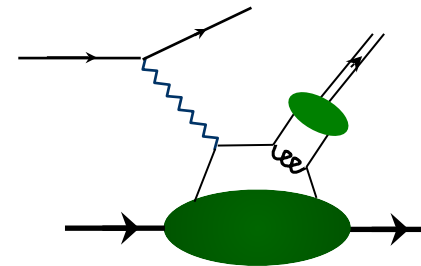

**DVMP**

*Virtual photon space-like*

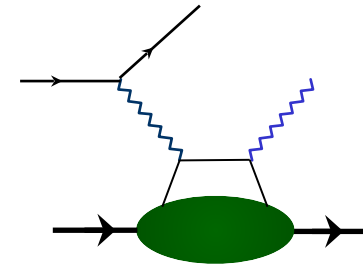

**DVCS**

*Virtual photon space-like*

# Deeply Virtual Compton Scattering

*the “golden channel” for GPD extraction*

- \* At high exchanged  $Q^2$  and low  $t$  access to four parton helicity-conserving, chiral-even GPDs:

$$E^q, \tilde{E}^q, H^q, \tilde{H}^q(x, \xi, t)$$

- \* Can be related to PDFs:

$$H(x, 0, 0) = q(x) \quad \tilde{H}(x, 0, 0) = \Delta q(x)$$

and form factors:

$$\int_{-1}^{+1} H dx = F_1 \quad \int_{-1}^{+1} \tilde{H} dx = G_A$$

$$\int_{-1}^{+1} E dx = F_2 \quad \int_{-1}^{+1} \tilde{E} dx = G_P$$

(Dirac and Pauli) (axial and pseudo-scalar)

- \* Small changes in nucleon transverse momentum allows mapping of transverse structure at large distances.

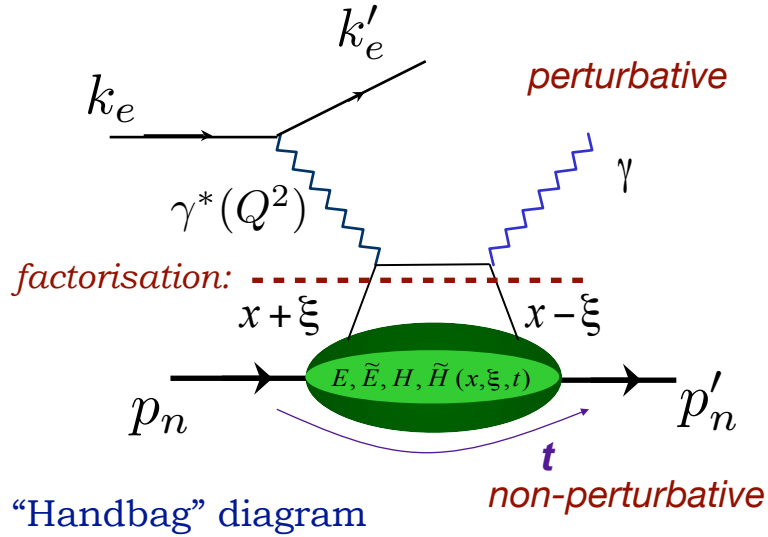

$$Q^2 = -(\mathbf{k} - \mathbf{k}')^2 \quad t = (\mathbf{p}'_n - \mathbf{p}_n)^2$$

$$\text{Bjorken variable: } x_B = \frac{Q^2}{2\mathbf{p}_n \cdot \mathbf{q}}$$

$x \pm \xi$  longitudinal momentum fractions of the struck parton

$$\text{Skewness: } \xi \cong \frac{x_B}{2 - x_B}$$



# Measuring DVCS

\* Process measured in experiment:

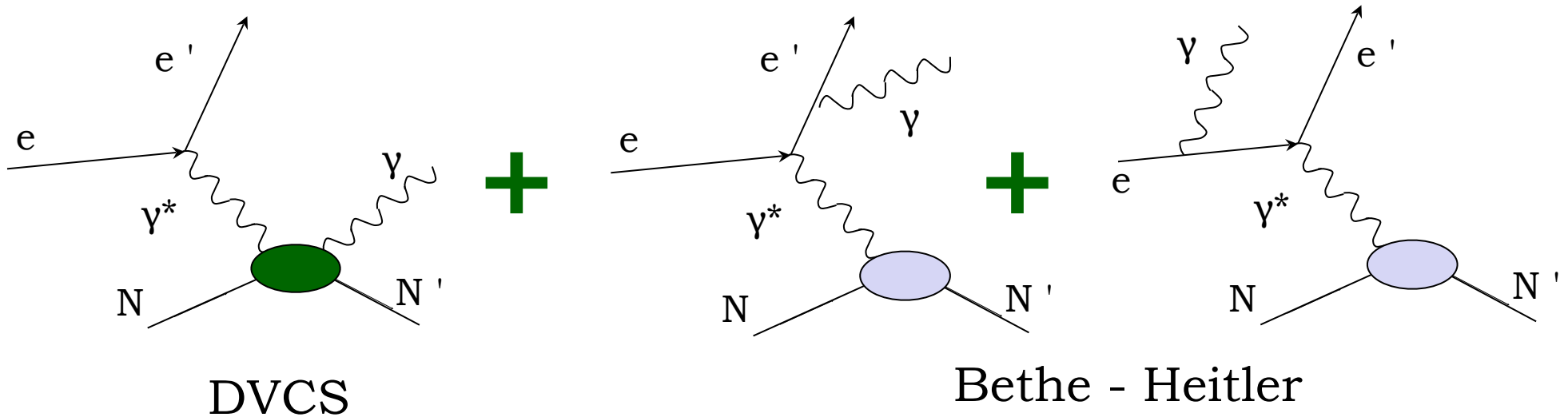

$$d\sigma \propto |T_{DVCS}|^2 + |T_{BH}|^2 + \underbrace{T_{BH} T_{DVCS}^* + T_{DVCS} T_{BH}^*}_{\text{Interference term}}$$

Amplitude  
parameterised in  
terms of Compton  
Form Factors

Amplitude calculable  
from elastic Form  
Factors and QED

Interference term

$$|T_{DVCS}|^2 \ll |T_{BH}|^2$$

# Compton Form Factors in DVCS

Experimentally accessible in DVCS cross-sections and spin asymmetries, eg:

$$A_{LU} = \frac{d\vec{\sigma} - d\bar{\sigma}}{d\vec{\sigma} + d\bar{\sigma}} = \frac{\Delta\sigma_{LU}}{d\vec{\sigma} + d\bar{\sigma}}$$

cross-sections,  
beam-charge and  
double polarisation asymmetries

single-spin  
asymmetries

At leading twist, leading order:

$$T^{DVCS} \sim \int_{-1}^{+1} \frac{GPDs(x, \xi, t)}{x \pm \xi + i\varepsilon} dx + \dots \sim P \int_{-1}^{+1} \frac{GPDs(x, \xi, t)}{x \pm \xi} dx \pm i\pi GPDs(\pm\xi, \xi, t) + \dots$$

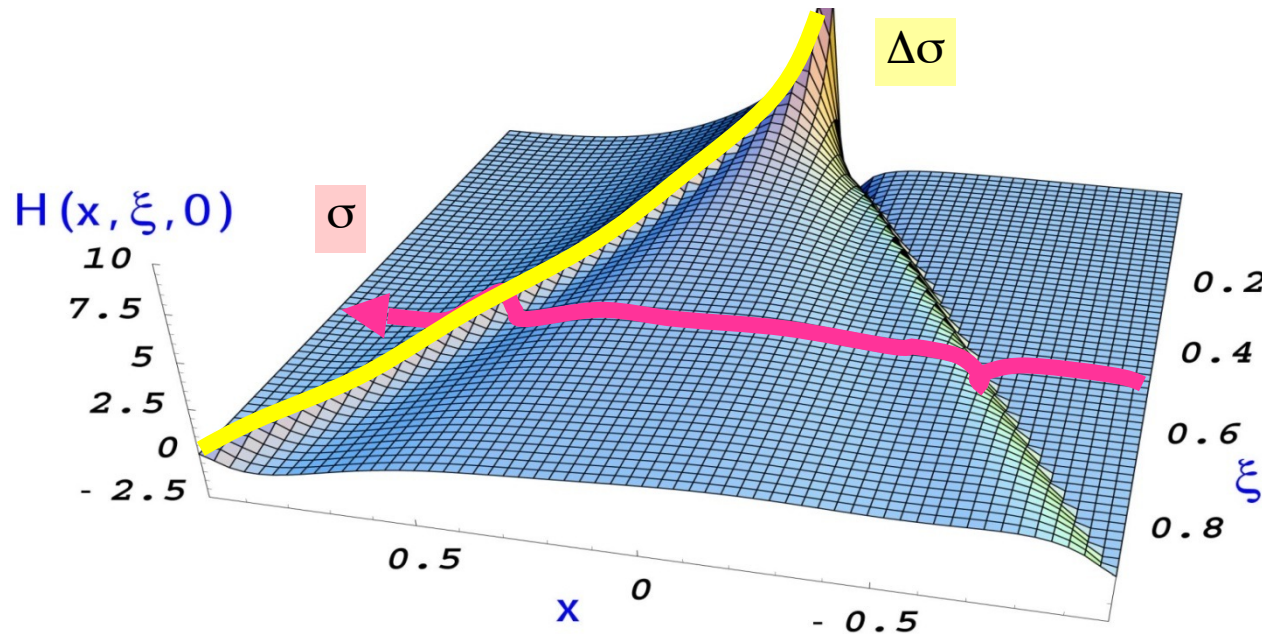

Only  $\xi$  and  $t$  are accessible experimentally!

To get information on  $x$  need extensive measurements in  $Q^2$ .

Need measurements off **proton** and **neutron** to get flavour separation of CFFs in DVCS.

# Jefferson Lab

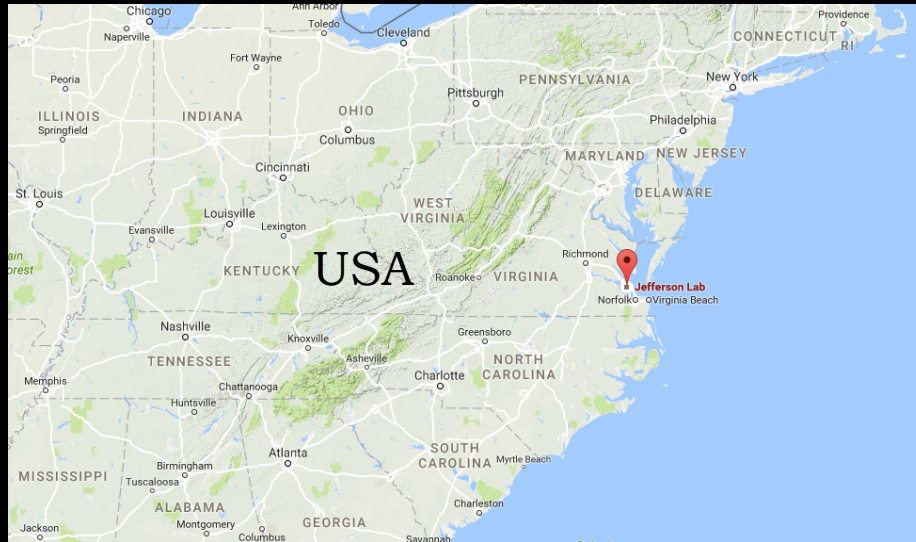

# Jefferson Lab: 6 GeV era

CEBAF: Continuous Electron Beam Accelerator Facility.

- \* Energy up to  $\sim 6$  GeV
- \* Energy resolution  $\delta E/E_e \sim 10^{-5}$
- \* Electron polarisation up to  $\sim 85\%$



Hall A:

Hall B: CLAS

Hall C:

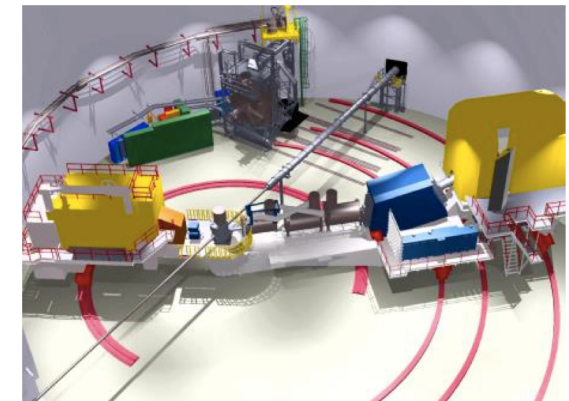
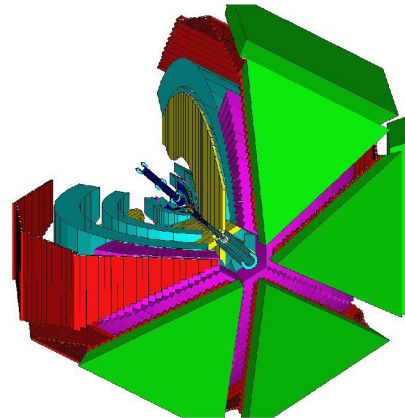
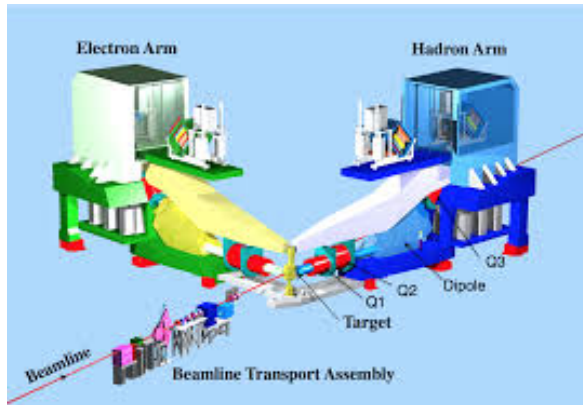

\* High resolution ( $\delta p/p = 10^{-4}$ ) spectrometers, very high luminosity.

\* Very large acceptance, detector array for multi-particle final states.

\* Two movable spectrometer arms, well-defined acceptance, high luminosity

# JLab @ 12 GeV

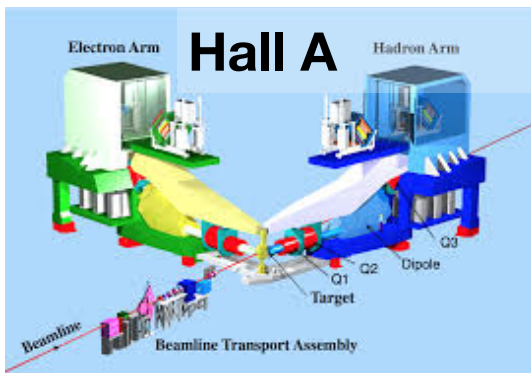

High resolution ( $\delta p/p = 10^{-4}$ ) spectrometers, very high luminosity, large installation experiments.

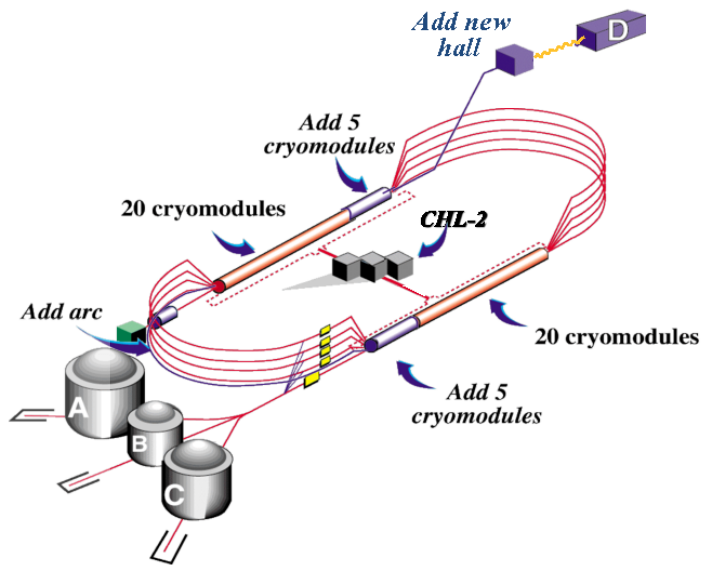

## Hall C

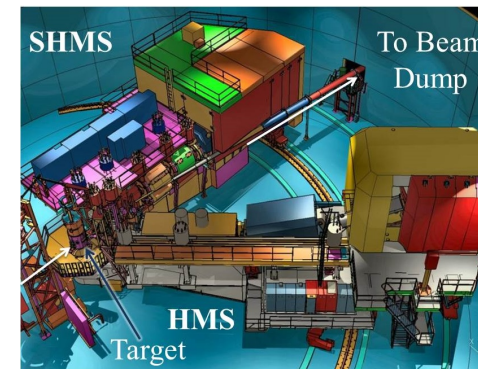

Two movable high momentum spectrometers, well-defined acceptance, very high luminosity.

GLUEX

## Hall D

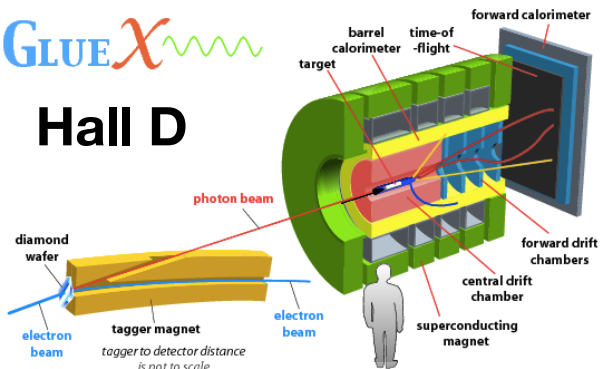

9 GeV tagged polarised photons, full acceptance

## Hall B: CLAS12

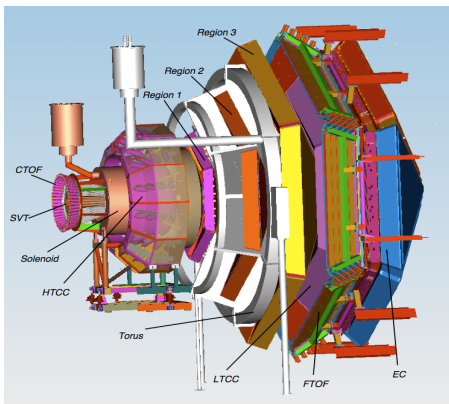

Very large acceptance, high luminosity.

# JLab @ 12 GeV

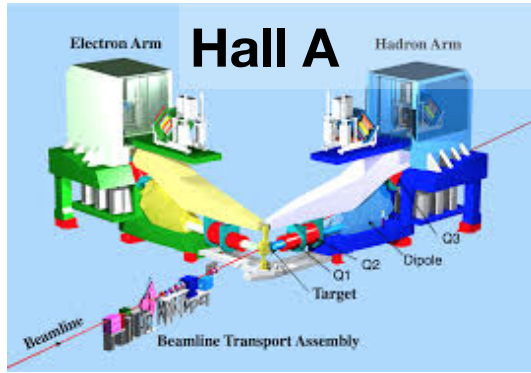

High resolution ( $\delta p/p = 10^{-4}$ ) spectrometers, very high luminosity, large installation experiments.

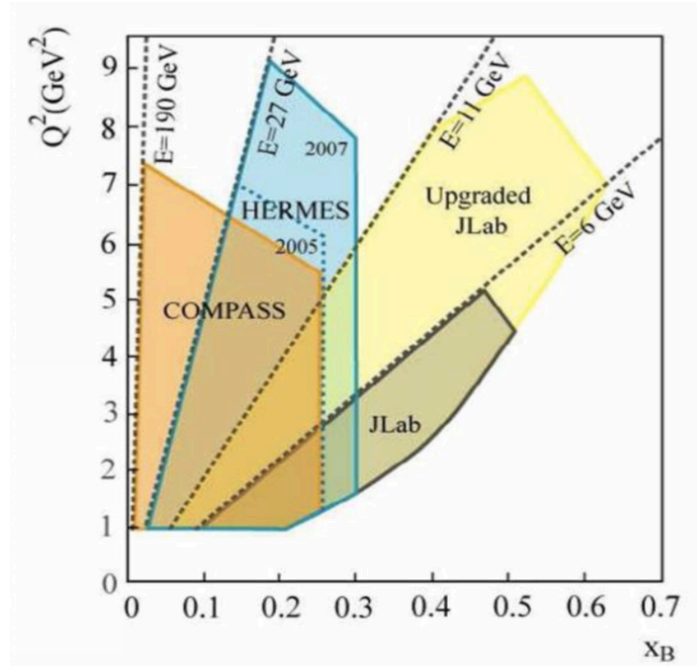

## Hall C

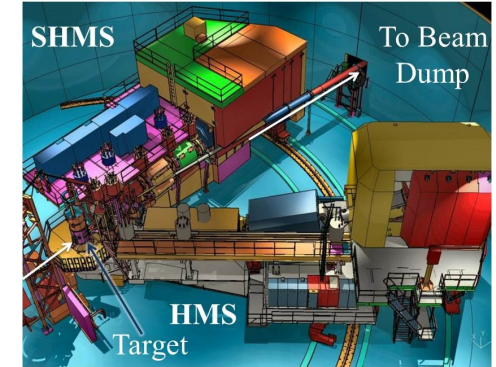

Two movable high momentum spectrometers, well-defined acceptance, very high luminosity.

## Hall B: CLAS12

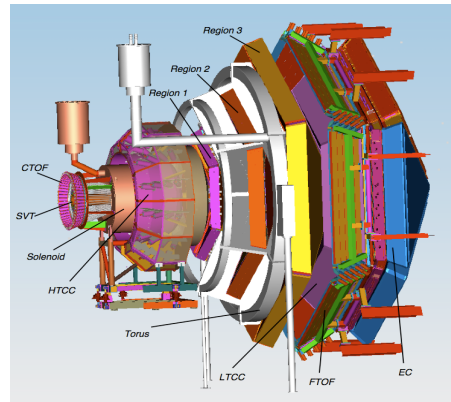

Very large acceptance, high luminosity.

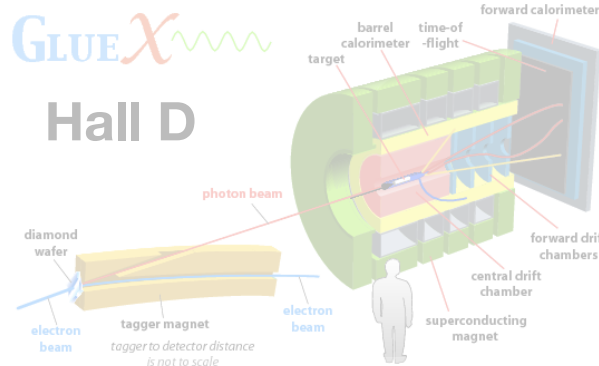

9 GeV tagged polarised photons, full acceptance

# CLAS12

Design luminosity

$$L \sim 10^{35} \text{ cm}^{-2} \text{ s}^{-1}$$

High luminosity & large acceptance:

Concurrent measurement of **exclusive**, **semi-inclusive**, and **inclusive** processes

Acceptance for photons and electrons:

$$\bullet 2.5^\circ < \theta < 125^\circ$$

Acceptance for all charged particles:

$$\bullet 5^\circ < \theta < 125^\circ$$

Acceptance for neutrons:

$$\bullet 5^\circ < \theta < 120^\circ$$

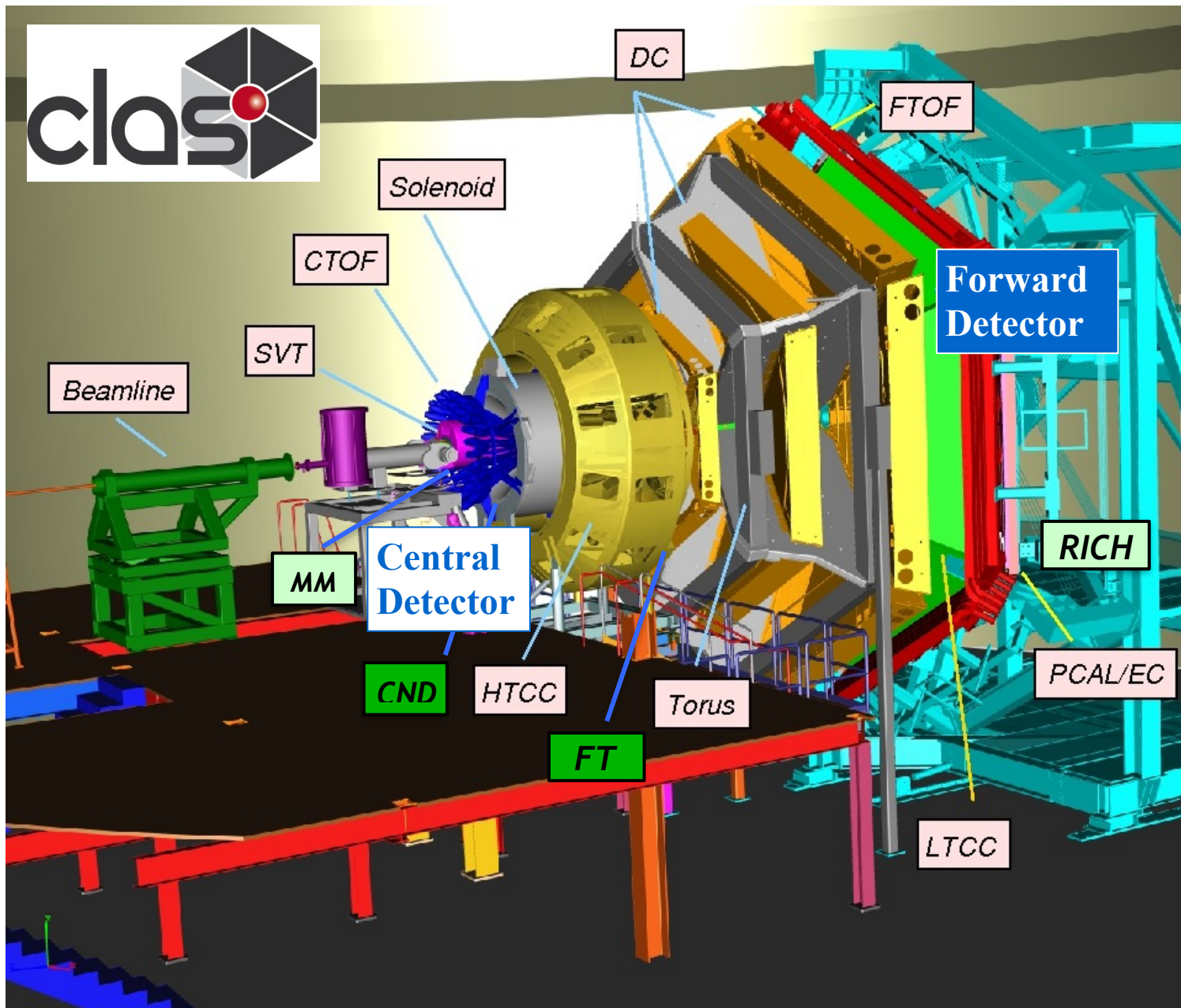

# DVCS in Hall C

Detect electron with (Super) High Momentum Spectrometer, (S)HMS.

Detect photon in PbWO<sub>4</sub> calorimeter.

Sweeping magnet to reduce backgrounds in calorimeter.

Reconstruct recoiling proton through missing mass.

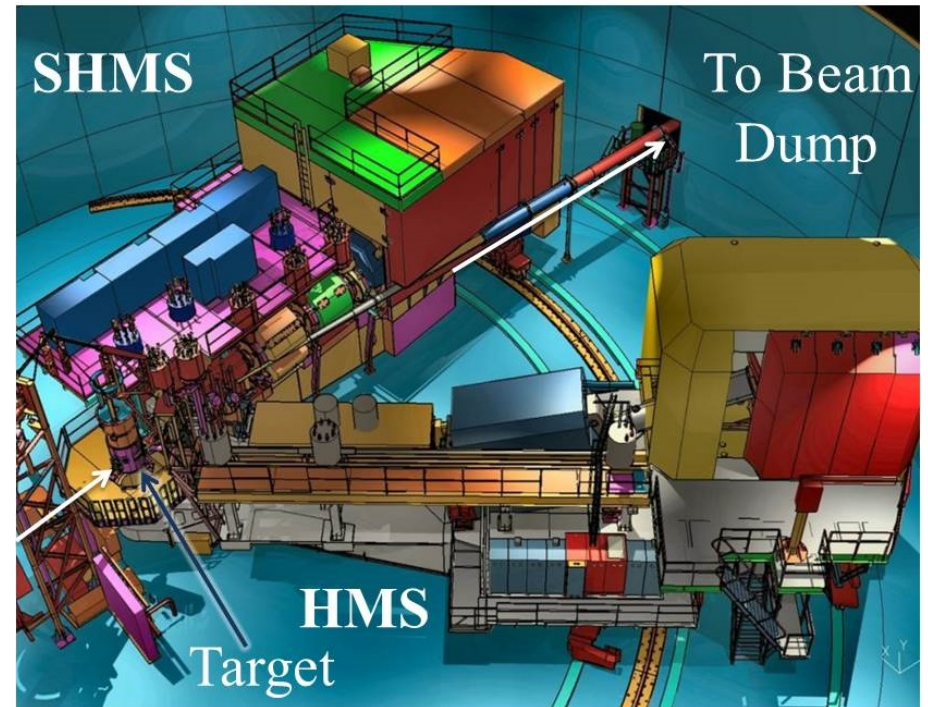

*Similar principle applied in Hall A*





**DVCS at JLab:  
6 GeV era**

# DVCS in Hall A

\* 15 cm long liquid  $H_2$  target

\* Luminosity =  $10^{37}$  cm $^{-2}$ s $^{-1}$

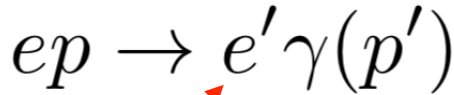

Detected in  
High Resolution  
Spectrometer  
(SRS)

Detected in PbF $_2$   
Calorimeter

Reconstructed  
through missing  
mass

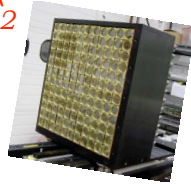

\* **E00-110 experiment**

(2004): 5.75 GeV polarised electron beam

\* Measure  $Q^2$ -dependence ( $Q^2$ : 1.5, 1.9, 2.3

GeV $^2$ ) of DVCS-BH cross-sections at fixed  $x_B$

(0.36) and  $x_B$  dependence at constant  $Q^2$ .

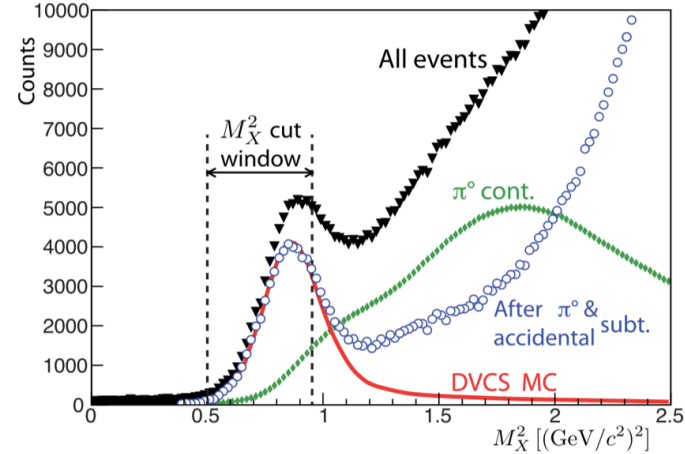
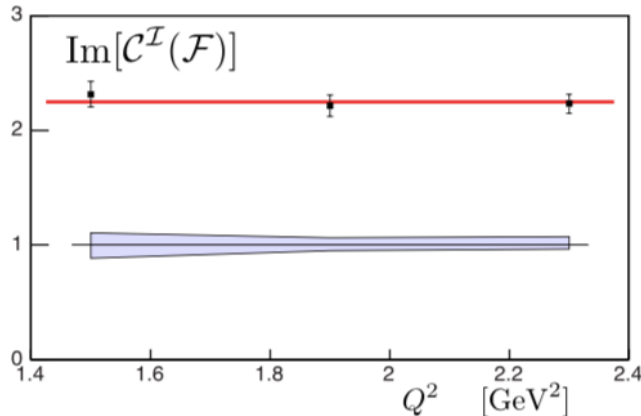

M. Defurne *et al*,  
**PRC 92** (2015)  
055202.

\* **E07-004 experiment** (2010):

Energy scan for fixed  $x_B$ ,  $Q^2$ :

$Q^2$ (GeV $^2$ )	$x_B$	$E^{\text{beam}}$ (GeV)	$-t$ (GeV $^2$ )
1.50	0.36	3.355	0.18, 0.24, 0.30
		5.55	
1.75	0.36	4.455	0.18, 0.24, 0.30, 0.36
		5.55	
2.00	0.36	4.455	0.18, 0.24, 0.30, 0.36
		5.55	

M. Defurne *et al*, **PRC 92** (2015) 055202.

# High-precision cross-sections: Hall A

- \* High precision cross-section measurement in a small kinematic region: Generalised Rosenbluth separation of the DVCS<sup>2</sup> (scales as  $E_e^2$ ) and the BH-DVCS interference (scales as  $E_e^3$ ) terms. **NLO and/or higher-twist improve model agreement.**

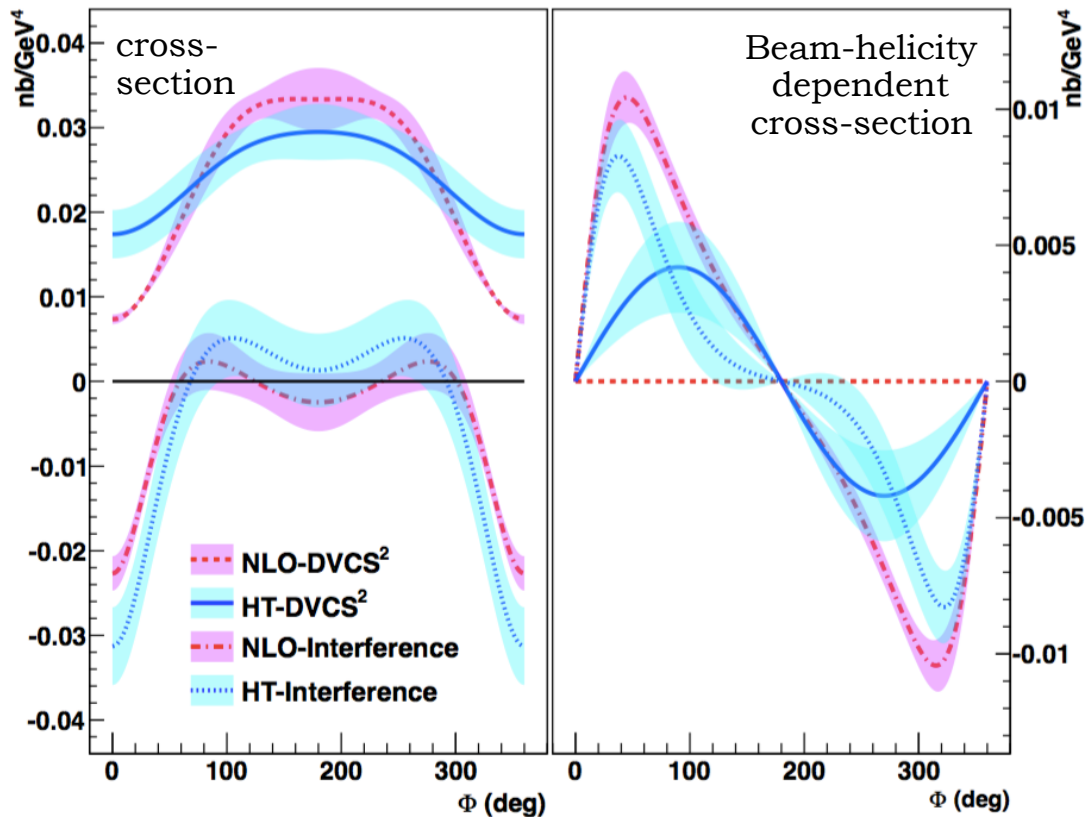

$Q^2$ : 1.5, 1.9, 2.3 GeV<sup>2</sup> at fixed  $x_B$  0.36  
 $-t$ : 0.18, 0.24, 0.30

$E_e$ : 4.5, 5.6 GeV.

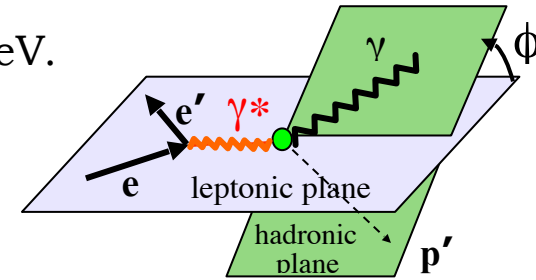

- \* Significant differences between pure DVCS and interference contributions.

- \* If NLO: sensitivity to gluons.

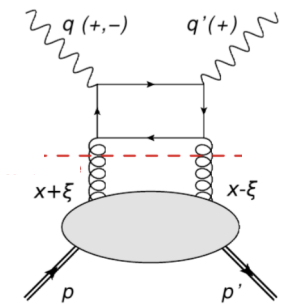

- \* Separation of HT and NLO effects requires scans across wider ranges of  $Q^2$  and beam energy: JLab12.

# Large kinematic coverage: CLAS

- \* Unpolarised DVCS cross-sections and helicity-dependent cross-section differences in a wide kinematic range:

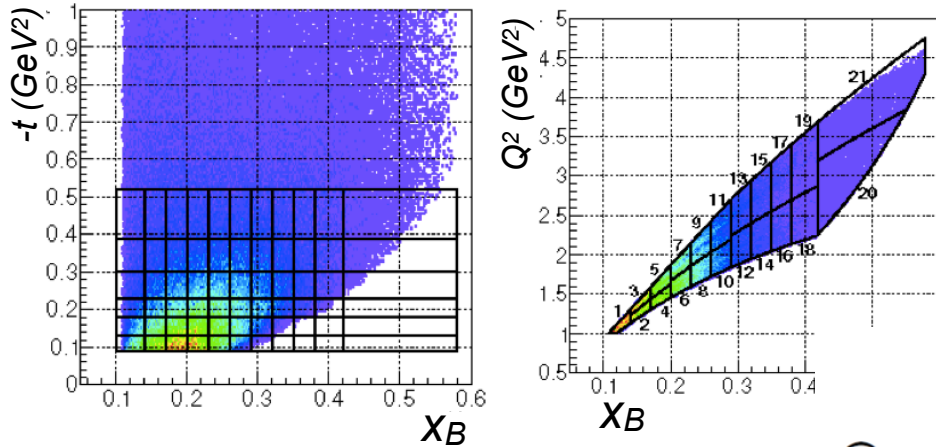

- BH only
- VGG (Vanderhaeghen, Guichon, Guidal) -  $H$  only
- ⋯ KM10 (Kumericki, Mueller) includes strong  $\tilde{H}$
- - - KM10a (sets  $\tilde{H}$  to zero)
- - - KMS (Kroll, Moutarde, Sabsatié, tuned on low  $x_B$  meson-production data)

- \* Widest phase space coverage in valence quark region: CFF constraints.

- \* Dominance of GPD  $H$  in unpolarised cross-section.

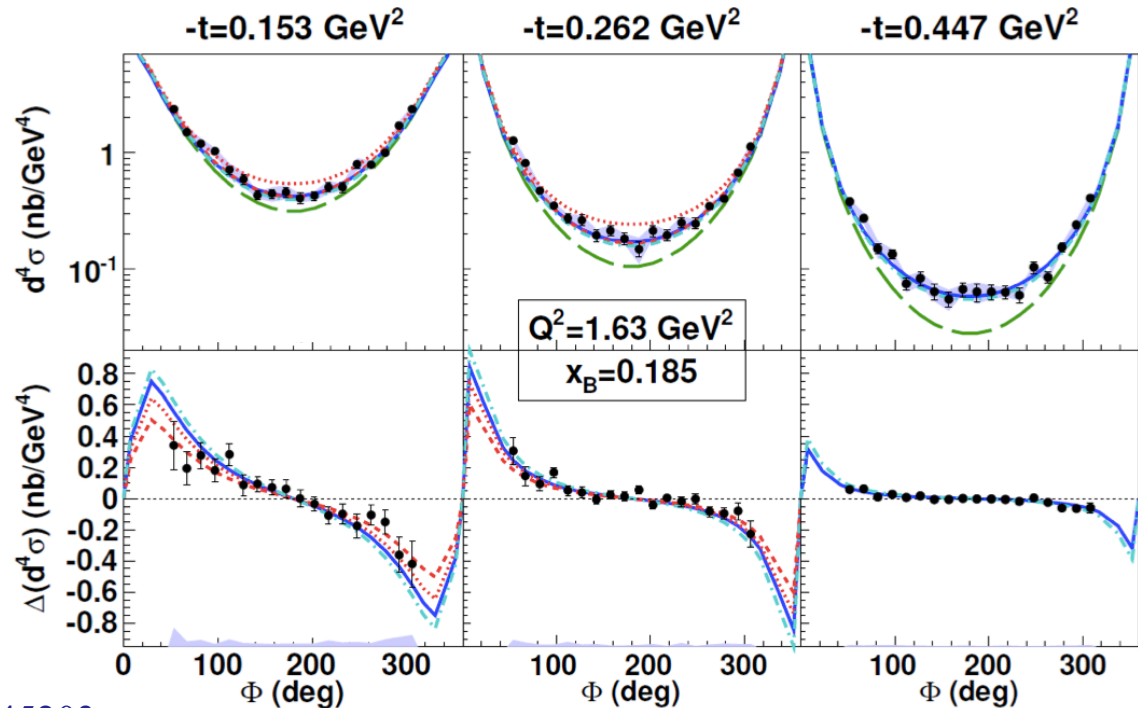

H.-S. Jo *et al* (CLAS), *PRL* **115** (2015) 212003

N. Hirlinger Saylor *et al* (CLAS), *PRC* **98** (2018) 045203

# CLAS unpolarised cross-sections

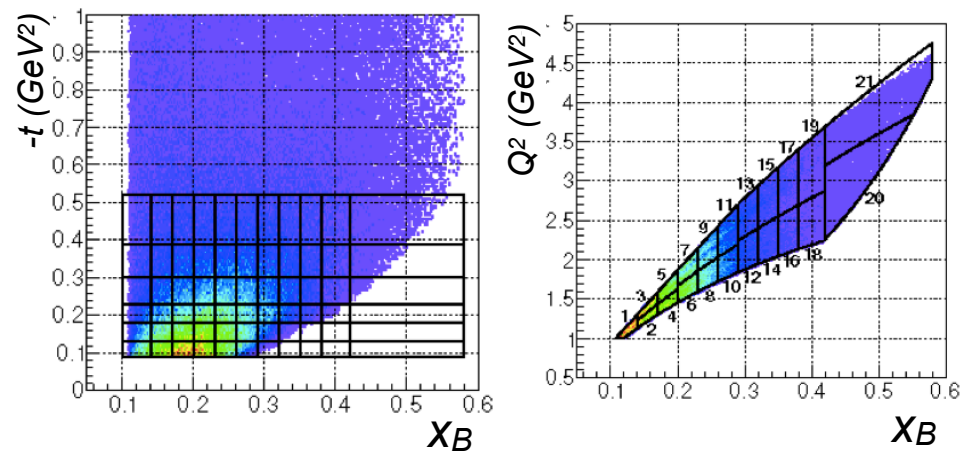

- BH only
- VGG (Vanderhaeghen, Guichon, Guidal) -  $H$  only
- ⋯ KM10 (Kumericki, Mueller) includes strong  $\tilde{H}$
- - KM10a (sets  $\tilde{H}$  to zero)
- - KMS (Kroll, Moutarde, Sabatié, tuned on low  $x_B$  meson-production data)

\* Widest phase space coverage in valence quark region: CFF constraints.

\* Dominance of GPD  $H$  in unpolarised cross-section.

$$\frac{d^4\sigma_{ep\rightarrow ep\gamma}}{dQ^2 dx_B dt d\Phi}$$

$$\frac{1}{2} \left( \frac{d^4\vec{\sigma}_{ep\rightarrow ep\gamma}}{dQ^2 dx_B dt d\Phi} - \frac{d^4\overleftarrow{\sigma}_{ep\rightarrow ep\gamma}}{dQ^2 dx_B dt d\Phi} \right)$$

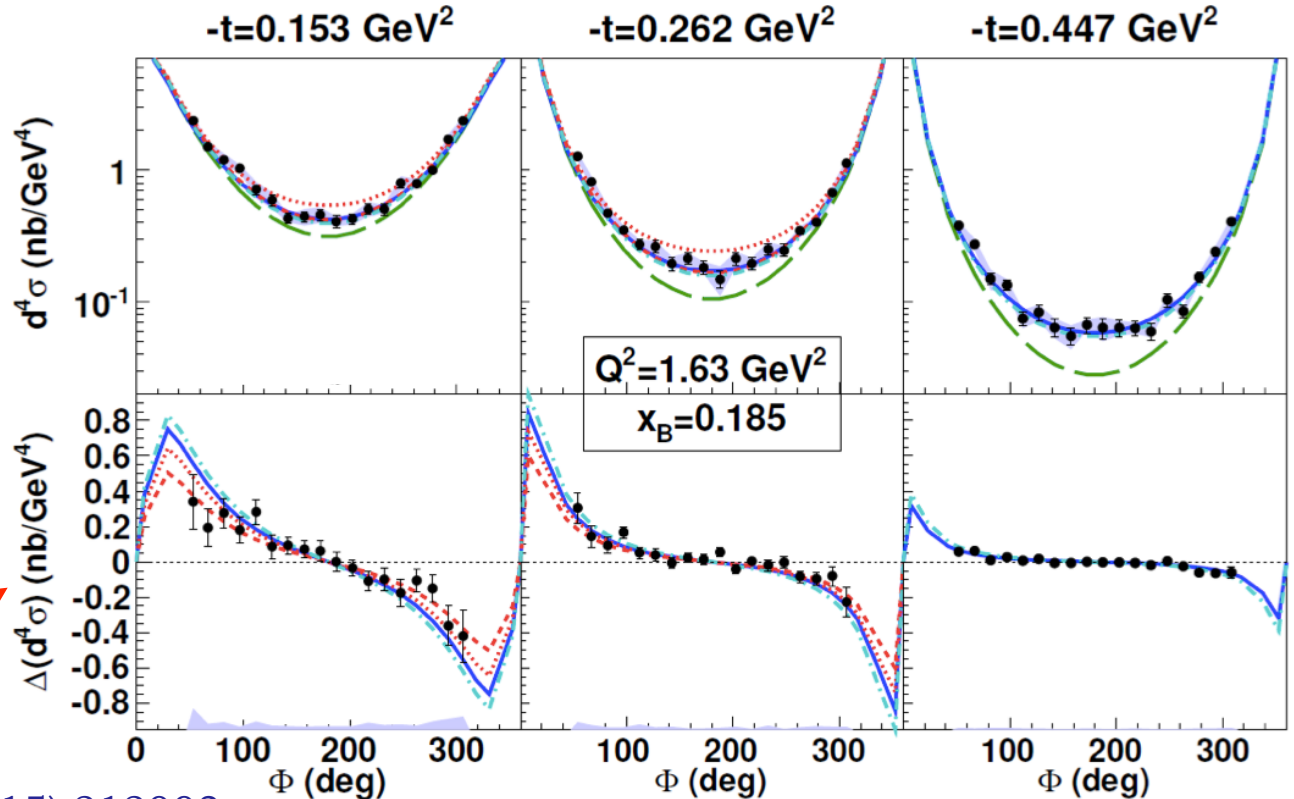

# DVCS asymmetries @ CLAS

High statistics, large kinematic coverage, strong constraints on fits, simultaneous fit of BSA, TSA and DSA at common kinematics from the same dataset:

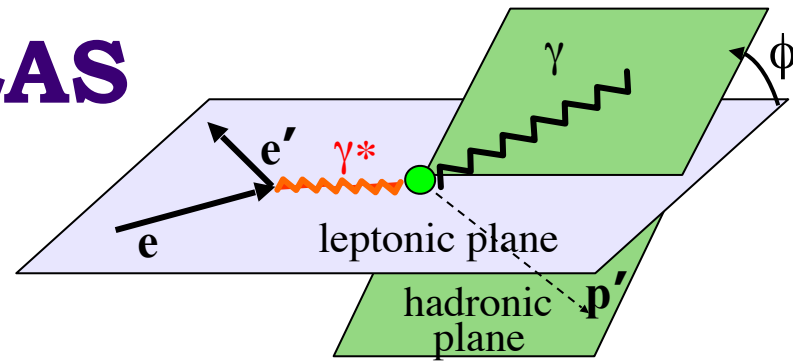

Beam-spin asymmetry (BSA):  $\Delta\sigma_{LU} \sim \sin\phi \Im(F_1 \overset{\circ}{H} + \xi G_M \tilde{H} - \frac{t}{4M^2} F_2 E) d\phi$

Target-spin asymmetry:  $\Delta\sigma_{UL} \sim \sin\phi \Im(F_1 \overset{\circ}{\tilde{H}} + \xi G_M (\overset{\circ}{H} + \frac{x_B}{2} E) - \xi \frac{t}{4M^2} F_2 \tilde{E} + \dots) d\phi$

Double-spin asymmetry:  $\Delta\sigma_{LL} \sim (A + B \cos\phi) \Re(F_1 \overset{\circ}{\tilde{H}} + \xi G_M (\overset{\circ}{H} + \frac{x_B}{2} E) + \dots) d\phi$

$F_1, F_2$ : Dirac, Pauli form factors

→ Constraints on CFFs  $H$  and  $\tilde{H}$

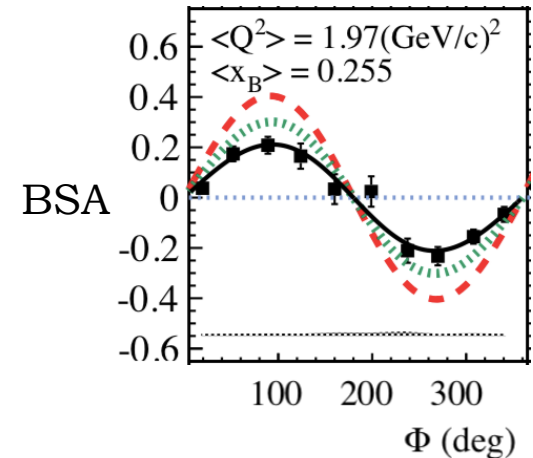

E. Seder *et al* (CLAS), **PRL 114** (2015) 032001

S. Pisano *et al* (CLAS), **PRD 91** (2015) 052014

F.-X. Girod *et al* (CLAS), **PRL 100** (2008) 162002

# Beam- and target-spin asymmetries

**CLAS**

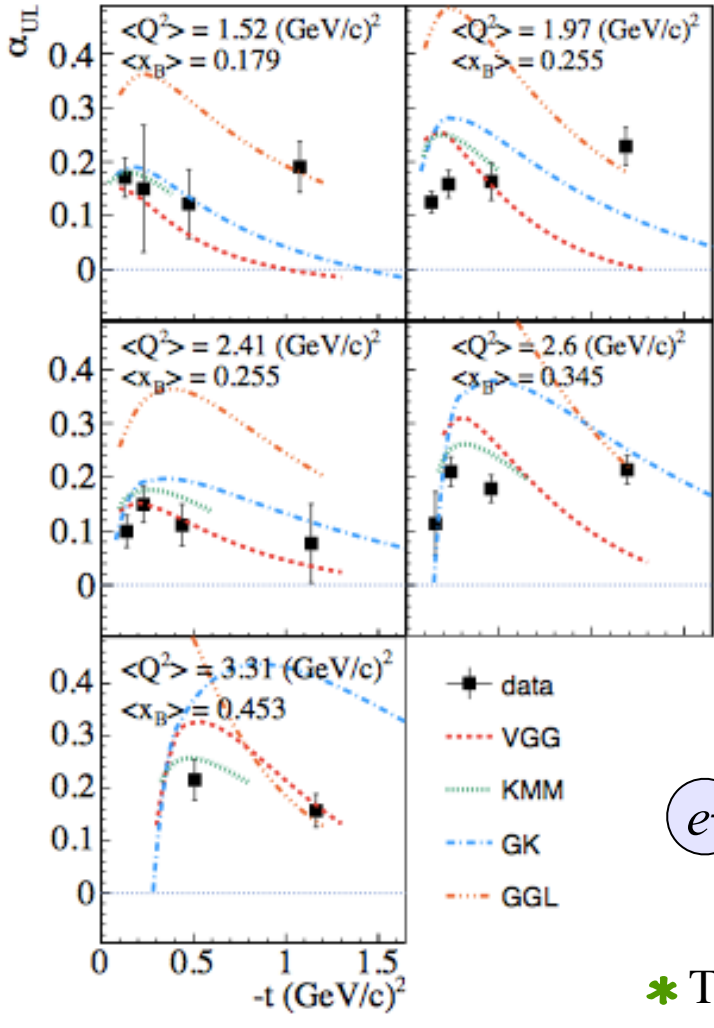
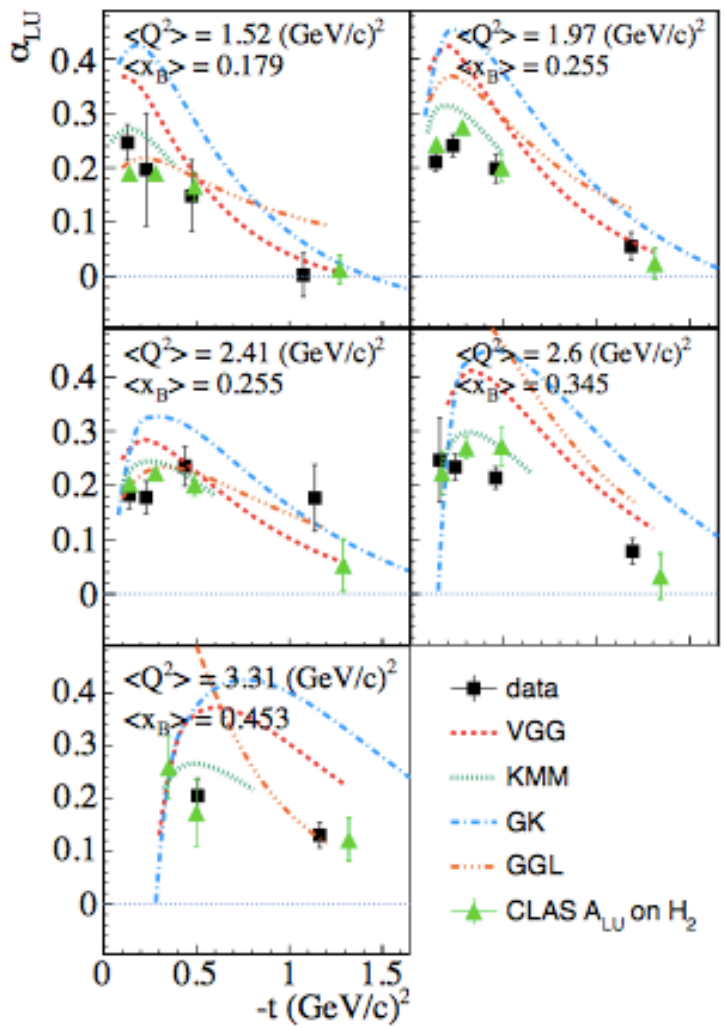

$$A = \frac{\alpha \sin \phi}{1 + \beta \cos \phi}$$

GGL: Goldstein, Gonzalez, Liuti

GK: Kroll, Moutarde, Sabatié

KMM: Kumericki, Mueller, Murray

VGG: Vanderhaeghen, Guichon, Guidal

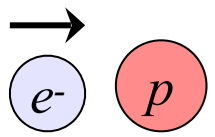

S. Pisano *et al* (CLAS), **PRD 91** (2015) 052014  
 E. Seder *et al* (CLAS), **PRL 114** (2015) 032001

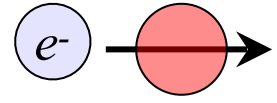

\* TSA shows a flatter distribution in  $t$  than BSA.

# Compton Form Factors from CLAS data

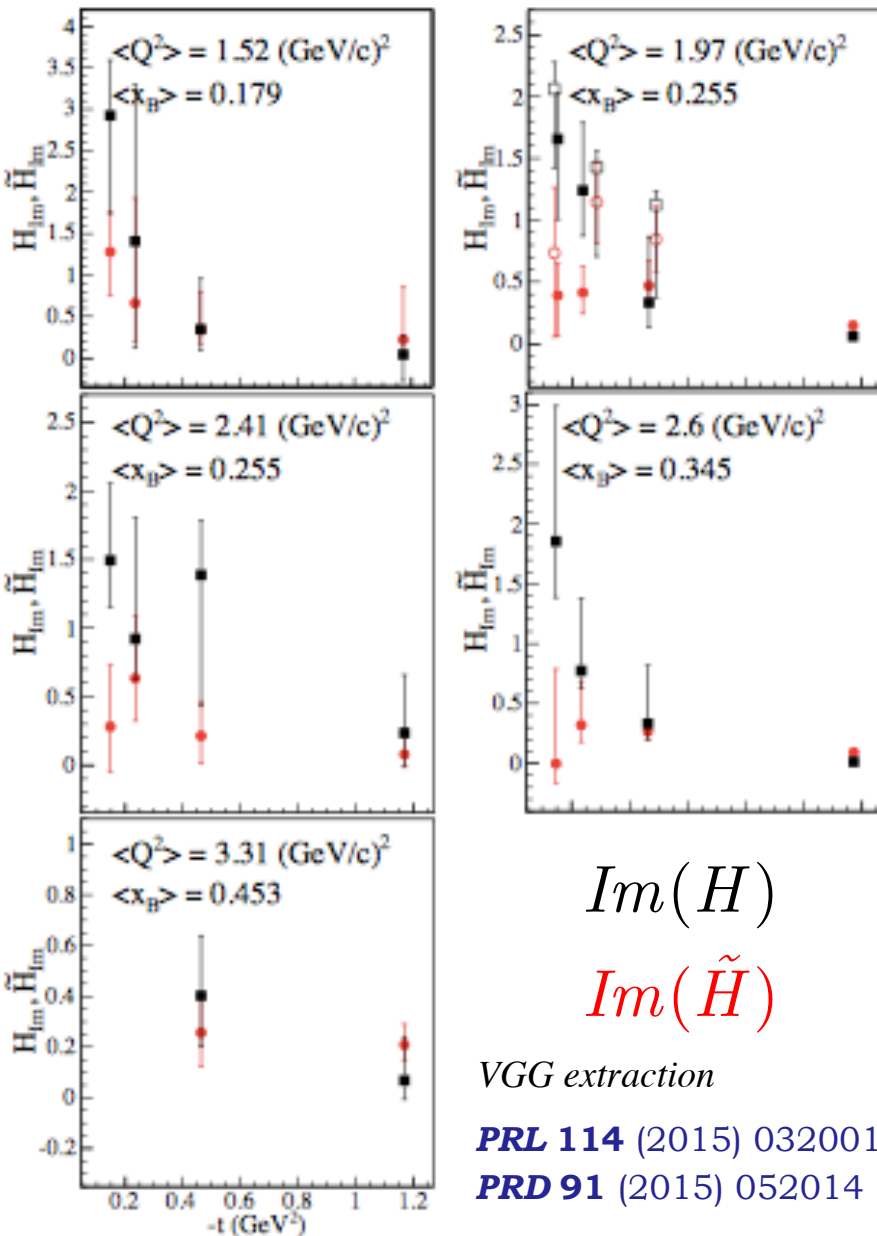

- \* Extracted using local fits to cross-sections and asymmetries, constrained by the VGG (Vanderhaeghen, Guichon, Guidal) model.

- \* Information on relative distributions of quark momenta (PDFs) and quark helicity,  $\Delta q(x)$

$$H(x, 0, 0) = q(x) \quad \tilde{H}(x, 0, 0) = \Delta q(x)$$

- \* Indications that axial charge is more concentrated than electromagnetic charge.

$$\int_{-1}^{+1} H dx = F_1 \quad \int_{-1}^{+1} \tilde{H} dx = G_A$$

- \* Slope flatter towards higher- $x$ : valence quarks are at centre, lower- $x$  quarks at periphery.

*Global analysis of all available data needed.*



# Towards nucleon tomography

\* **Local fit** to extract CFFs: limits based on +/- 5 \* the VGG (Vanderhaeghen, Guichon, Guidal) model predictions using leading-twist amplitude based on Double Distributions.

\* Assuming leading-twist and exponential dependence of GPD on  $t$ , using models to extrapolate to the zero skewness point  $\xi = 0$  and assuming similar behaviour for  $u$  and  $d$  quarks there:

$$\langle b_{\perp}^2 \rangle^q(x) = -4 \frac{\partial}{\partial \Delta_{\perp}^2} \ln H_{-}^q(x, 0, -\Delta_{\perp}^2) \Big|_{\Delta_{\perp} = 0}$$

$$H_{-}^q(x, 0, t) \equiv H^q(x, 0, t) + H^q(-x, 0, t) \quad \boxed{t = \Delta^2}$$

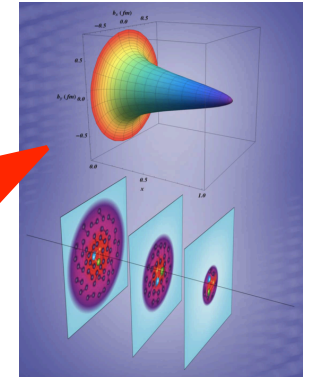
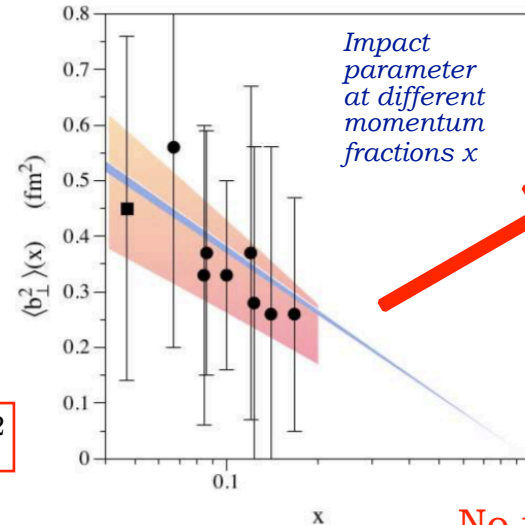

R. Dupré *et al.*, Eur. Phys. J **A 53**, (2017) 171

No uncertainties shown!

\* **Global fits:** PARTONS framework using neural networks to minimise model-dependence in the extraction of CFFs.

*We need more data from multiple channels and across a wide kinematic range!*

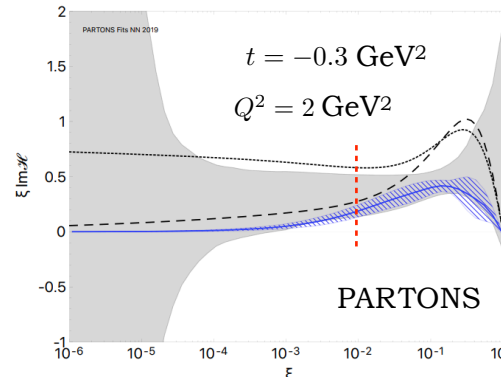

H. Moutarde *et al.*, Eur. Phys. J **C79**, 614 (2019)

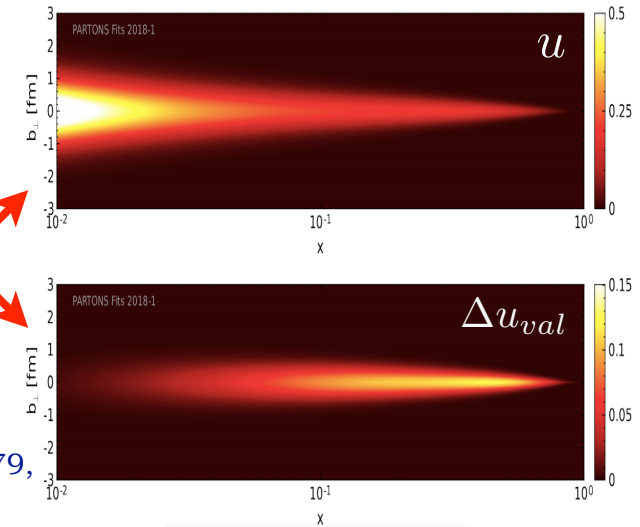

# DVCS on the neutron: Hall A

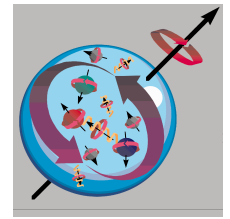

$$J_N = \frac{1}{2} = \frac{1}{2} \Sigma_q + L_q + J_g$$

\* Ji's relation:  $J^q = \frac{1}{2} - J^g = \frac{1}{2} \int_{-1}^1 x dx \left\{ H^q(x, \xi, 0) + E^q(x, \xi, 0) \right\}$

- \*  $H^q$  in DVCS off the proton, first experimental constraint on  $E^q$  from neutron-DVCS beam-spin asymmetry.

M. Mazouz et al, PRL 99 (2007) 242501

- \* Gives constraints on orbital angular momentum of quarks: **the spin puzzle.**

- \* Rosenbluth separation of interference & DVCS terms underway in neutron-DVCS cross-sections:  $E_e = 4.5$  and  $5.5$  GeV (experiment E08-025).

LD<sub>2</sub> target  $\langle Q^2 \rangle = 1.75 \text{ GeV}^2$   $\langle x_B \rangle = 0.36$

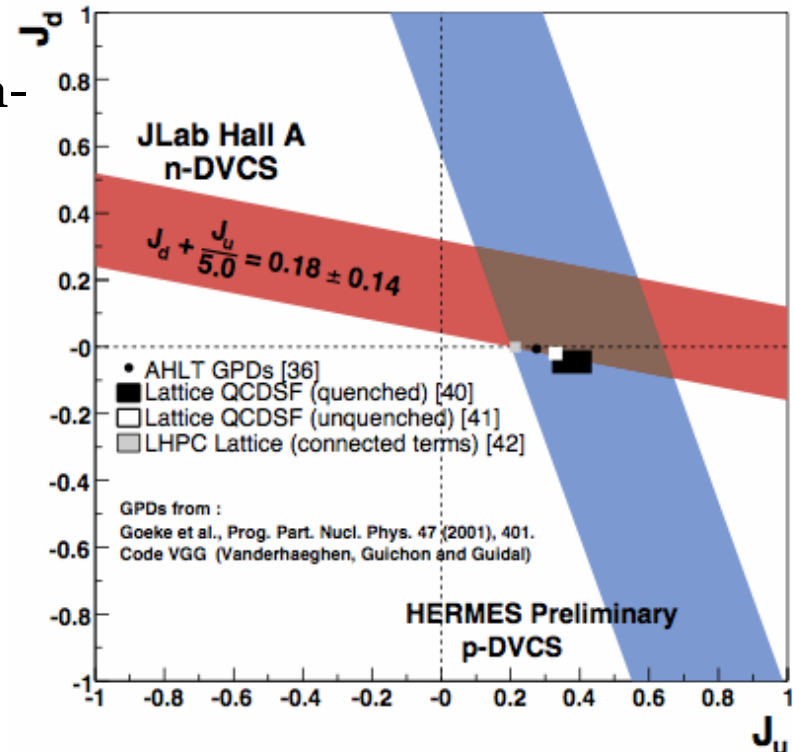

# DVCS on the bound proton

CLAS

- \* Beam spin asymmetry in DVCS from bound protons in  $^4\text{He}$ .

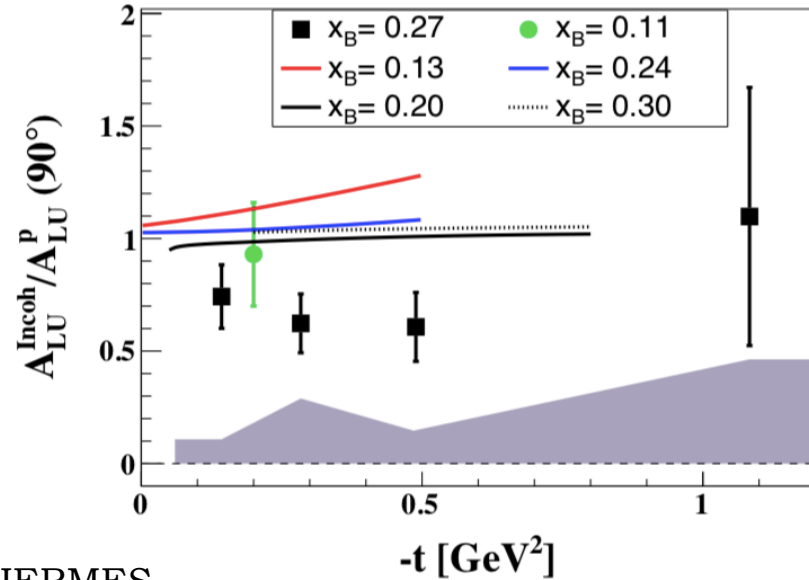
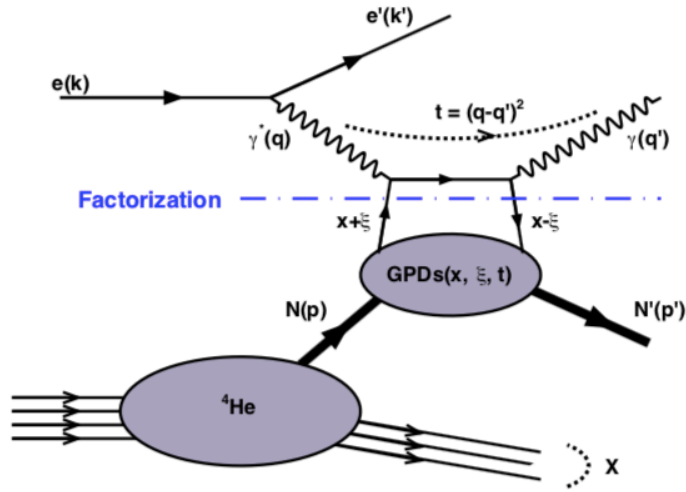

● HERMES

— Off-shell: S. Liuti, K. Taneja, PRC72, 032201 (2005)

— On-shell: V. Guzey, A. Thomas, K. Tsushima, PLB673, 9 (2009)

- \* 25% - 40% lower asymmetries for bound proton compared to free, no strong dependence on  $t$ .

- \* Medium-modification effects, initial/final state interactions?

# Imaging pressure within the nucleon

- \* GPDs provide indirect access to mechanical properties of the nucleon (encoded in the gravitational form factors, GFFs, of the energy-momentum tensor).

X. D. Ji, *PRD* **55**, 7114-7125 (1997)

M. Polyakov, *PLB* **555**, 57-62 (2016)

- \* Three scalar GFFs, functions of  $t$ : encode pressure and shear forces ( $d_1(t)$ ), mass ( $M_2(t)$ ) and angular momentum distributions ( $J(t)$ ).

- \* Can be related to GPDs via sum rules:

$$\int x [H(x, \xi, t) + E(x, \xi, t)] dx = 2J(t)$$

$$\int x H(x, \xi, t) dx = M_2(t) + \frac{4}{5} \xi^2 d_1(t)$$

- \* Severely model-dependent extraction
- \* Neural net analysis, however: d-term almost unconstrained and consistent with zero

Possibility of extracting pressure distributions! But more data needed.

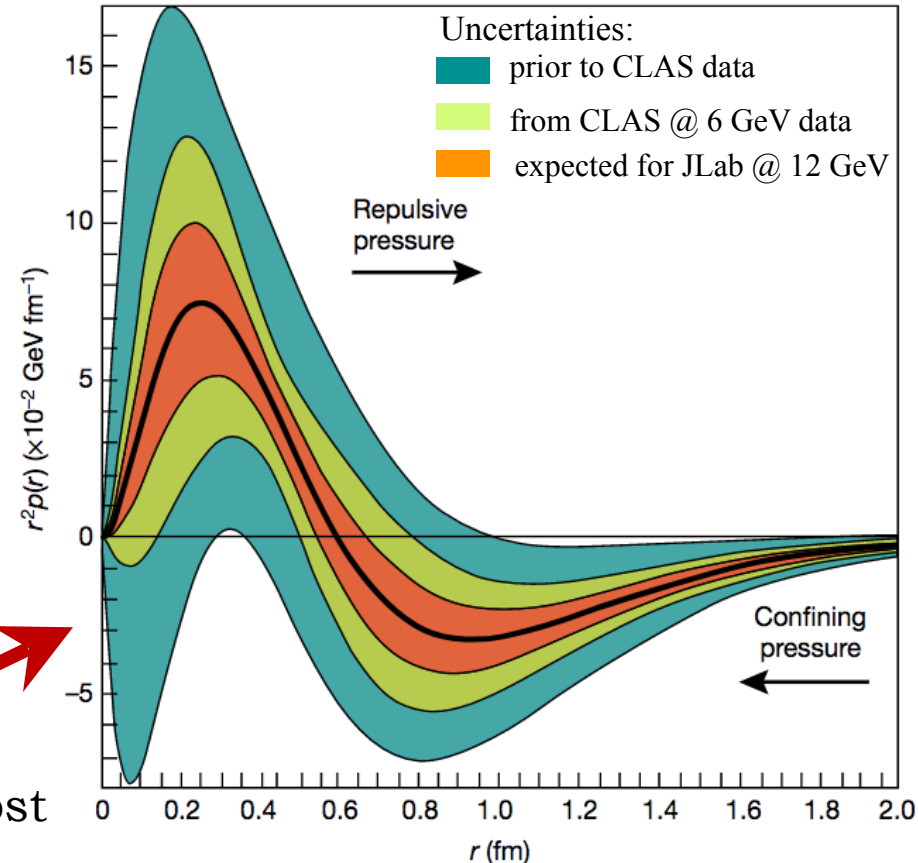

V. Burkert, L. Elouadrhiri, F.-X. Girod, *Nature* **557**, 396-399 (2018)

K. Kumerički, *Nature* **570**, E1-E2 (2019)



**DVCS at JLab12:  
11 GeV era**

# 11 GeV era DVCS Cross-sections: Halls A and C

*Experiments:*

**E12-06-114** (Hall A, 100 days),

**E12-13-010** (Hall C, 53 days)

**Unpolarised liquid H<sub>2</sub> target:**

- Beam energies: 6.6, 8.8, 11 GeV
- Scans of  $Q^2$  at fixed  $x_B$ .
- Hall A: aim for absolute cross-sections with 4% relative precision.

---

\* Azimuthal, energy and helicity dependencies of cross-section to separate  $|T_{DVCS}|^2$  and interference contributions in a wide kinematic coverage.

\* Separate *Re* and *Im* parts of the DVCS amplitude.

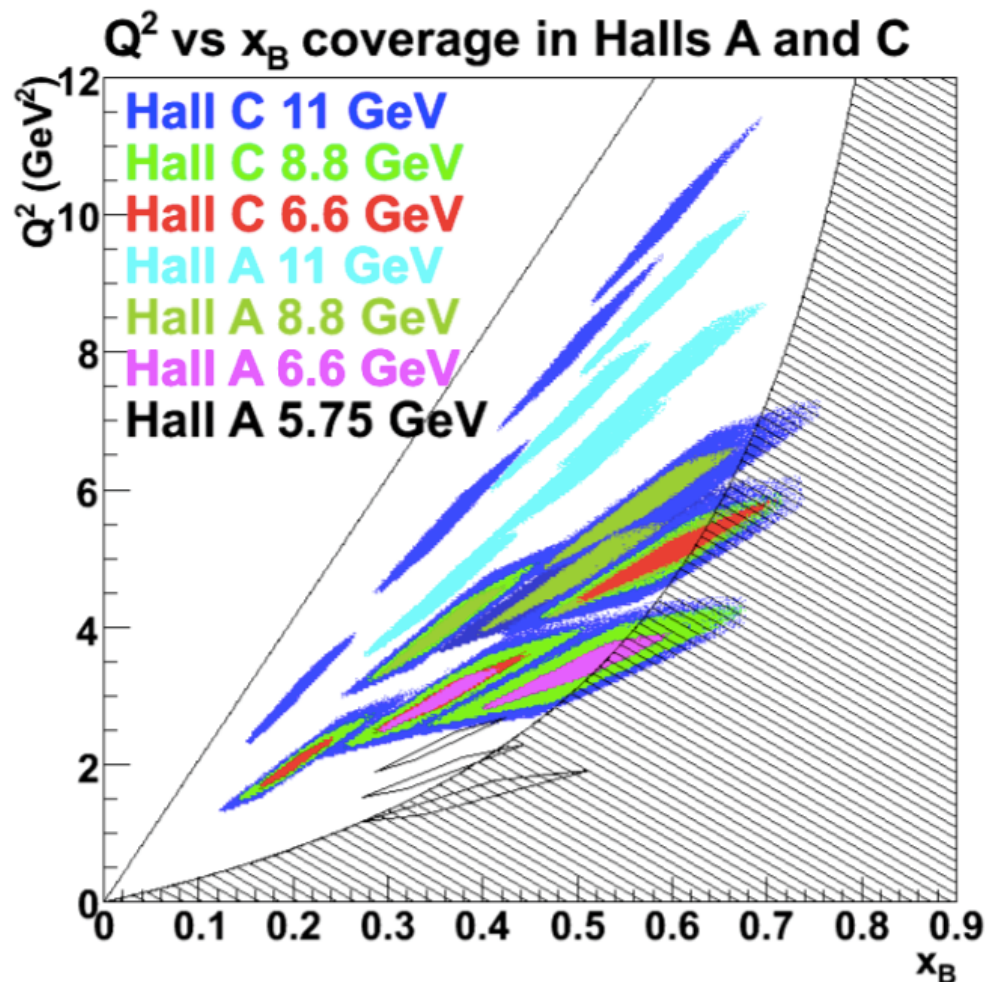

# 11 GeV era: DVCS with CLAS12

**E12-06-119:** Unpolarised liquid H<sub>2</sub> target

Beam-spin asymmetry  $\longrightarrow$   $Im(\mathbf{H}_p)$

**First experiment with CLAS12!** ~50% done

-----

**E12-16-010:** Unpolarised liquid H<sub>2</sub> target

Beam energy: 6.6 GeV, 8.8 GeV *Almost complete*

**E12-11-003:** Unpolarised liquid D<sub>2</sub> target

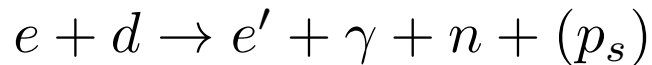

Beam-spin asymmetry  $\longrightarrow$   $Im(\mathbf{E}_n)$   
in neutron-DVCS  
*Running this year!*

**E12-12-010:** Transversely polarised HD target.

Target-spin asymmetries  $\longrightarrow$   $Im(\mathbf{E}_p)$   
*~2023?*

**E12-06-109:** Longitudinally polarised NH<sub>3</sub> and ND<sub>3</sub> targets

- **Dynamic Nuclear Polarisation** (DNP) of target material, cooled in a He evaporation cryostat.
- $P_{\text{proton}} = 80\%$ ,  $P_{\text{deuteron}}$  up to 50%

Target-spin asymmetry in proton- and neutron-DVCS  $\longrightarrow$   $Im(\tilde{\mathbf{H}}_p)$ ,  $Im(\mathbf{H}_n)$   
*~ 2021*

$$P_{\text{beam}} = 85\%$$

$$L = 10^{35} \text{ cm}^{-2}\text{s}^{-1}$$

$$1 < Q^2 < 10 \text{ GeV}^2$$

$$0.1 < x_B < 0.65$$

$$-t_{\text{min}} < -t < 2.5 \text{ GeV}^2$$

# DVCS with CLAS12

**E12-06-119:** Unpolarised liquid H<sub>2</sub> target

Beam-spin asymmetry  $\longrightarrow$   $Im(H_p)$

**First experiment with CLAS12!** ~50% done

$$P_{\text{beam}} = 85\%$$

$$L = 10^{35} \text{ cm}^{-2}\text{s}^{-1}$$

$$1 < Q^2 < 10 \text{ GeV}^2$$

$$0.1 < x_B < 0.65$$

$$-t_{\text{min}} < -t < 2.5 \text{ GeV}^2$$

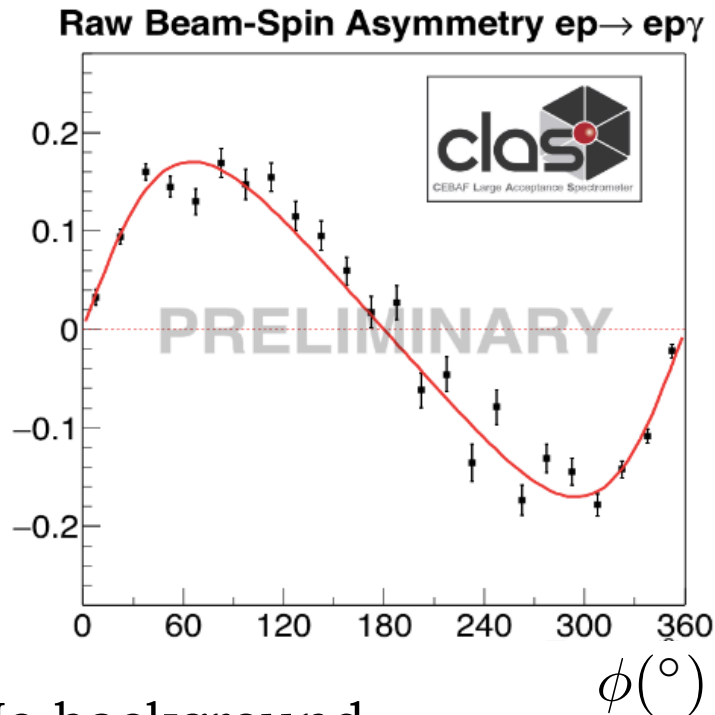

No background subtraction

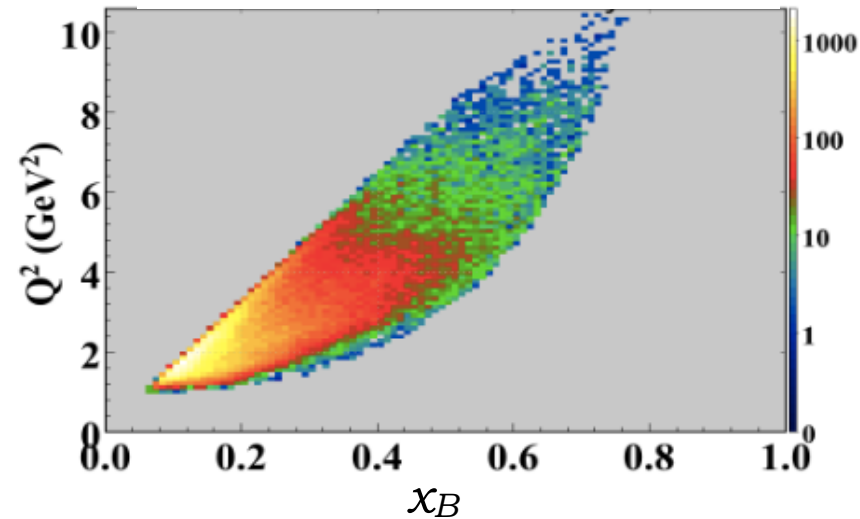

*Guillaume Christiaens*



# Neutron DVCS @ 11 GeV: sensitivity to $J_q$

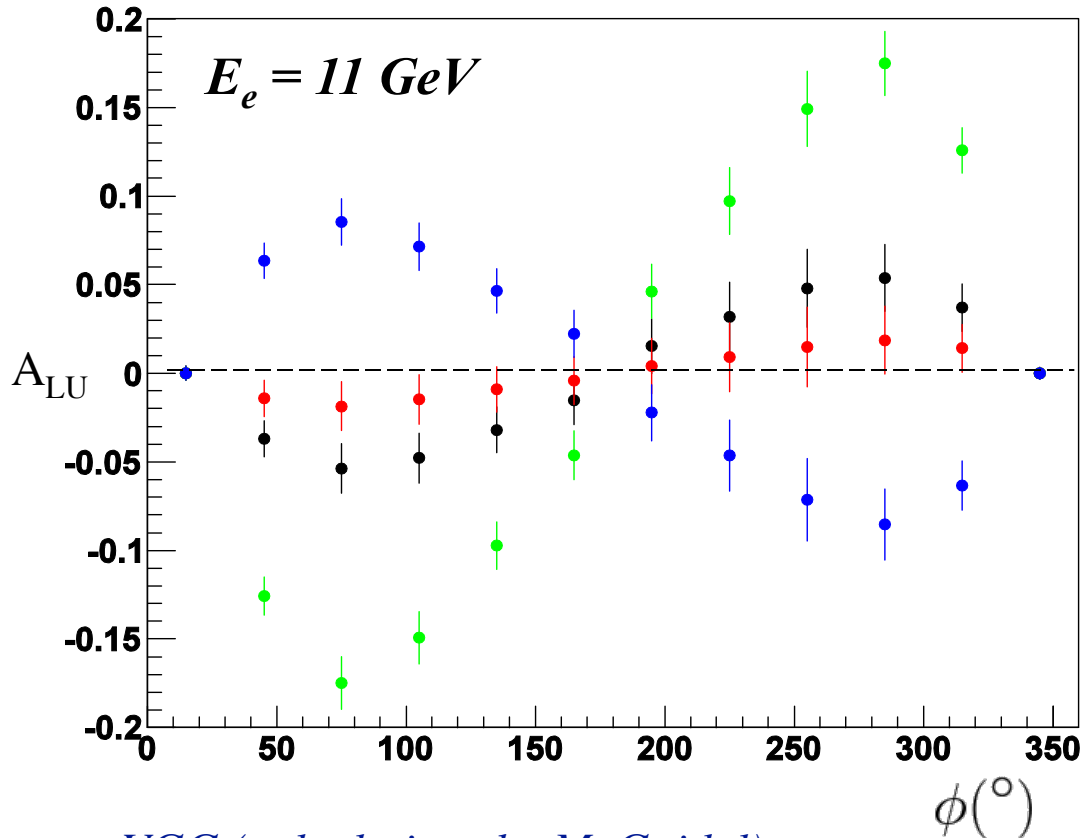

VGG (calculations by M. Guidal)

$$x_B = 0.17 \quad Q^2 = 2 \text{ GeV}^2 \quad t = -0.4 \text{ GeV}^2$$

$$J_u = 0.3, J_d = -0.1 \quad J_u = 0.3, J_d = 0.1$$

$$J_u = 0.1, J_d = 0.1 \quad J_u = 0.3, J_d = 0.3$$

\* At 11 GeV, beam spin asymmetry ( $A_{LU}$ ) in neutron DVCS is **very** sensitive to  $J_u, J_d$

\* Dedicated neutron detector added to CLAS12: Central Neutron Detector

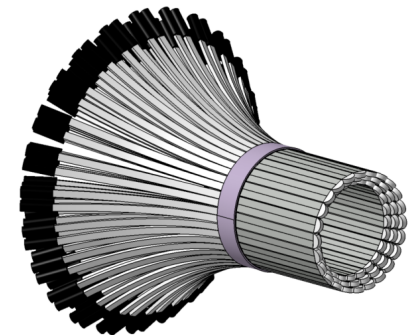

**Measurement currently in process...**

# DVCS on $^4\text{He}$ : CLAS12 with ALERT

Experiment E12-17-012: Measurement of BSA in coherent DVCS from a  $^4\text{He}$  target: partonic structure of nuclei.

- \* Builds on 6 GeV measurement: [M. Hattawy \*et al\*, PRL 119 \(2017\) 202004.](#)
- \* Spin 0 target, so at leading twist only one chiral-even GPD:  $\mathbf{H}_A$ .

11 GeV beam, 80% polarised.  
Gas target straw @ 3 atm  
 $L = 6 \times 10^{34}$  nucleon  $\text{cm}^{-2}\text{s}^{-1}$   
with 1000 nA beam.

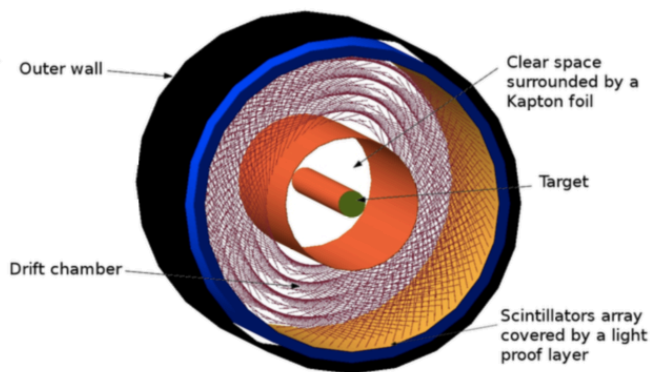

CLAS12 + ALERT: central recoil detector

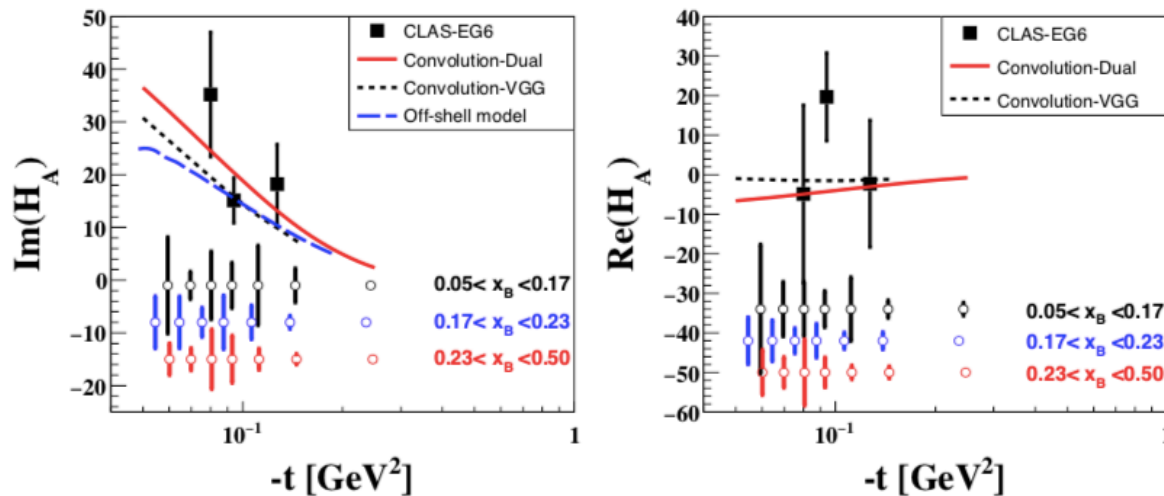

Experiment E12-17-012B

Incoherent, spectator-tagged DVCS on  $^4\text{He}$  and  $d$ .



**Hard Exclusive  
Meson  
Production**

# Hard Exclusive Meson Production

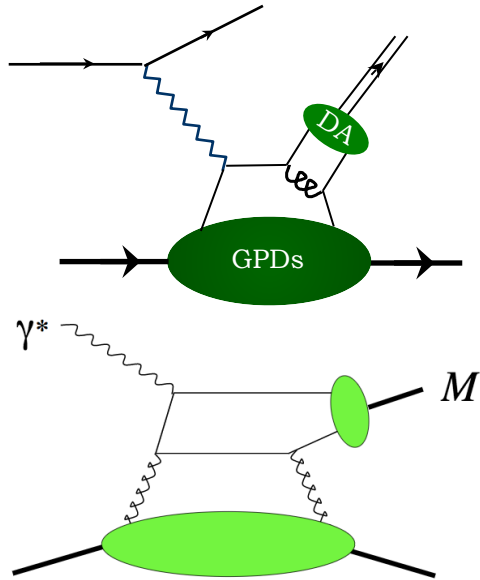

\* Amplitude depends on convolution of GPDs and meson Distribution Amplitudes (DA).

\* At leading order & twist, access to the four chiral-even (parton helicity-conserving) GPDs:

- Pseudo-scalar mesons:  $\tilde{H}^q, \tilde{E}^q(x, \xi, t)$
- Vector mesons:  $H^q, E^q, H^g, E^g(x, \xi, t)$  → Gluon GPDs!

HEMP enables flavour decomposition of quark GPDs and gives access to gluon GPDs

- Caveats:**
- factorisation established only for longitudinal photons,
  - factorisation sets in at a higher scale than in DVCS,
  - DA not entirely understood

*Extracting GPDs from HEMP is hard!*

# HEMP Cross-section

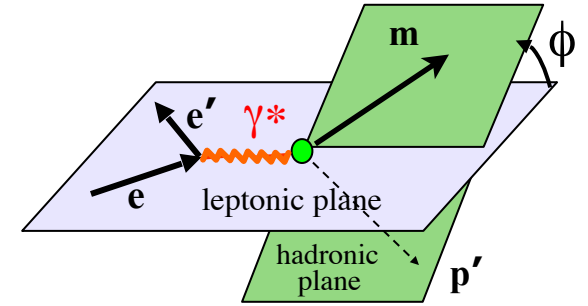

Virtual  
photon flux

*unpolarised*

$$\frac{2\pi}{\Gamma} \frac{d^4 \sigma}{dQ^2 dx_B dt d\phi_{meson}} = \boxed{\sigma_T + \epsilon \sigma_L + \epsilon \sigma_{TT} \cos 2\phi + \sqrt{\epsilon(1+\epsilon)} \sigma_{LT} \cos \phi}$$

*polarised beam*

$$\boxed{+ P_b \sqrt{\epsilon(1-\epsilon)} \sigma_{LT} \sin \phi}$$

*longitudinally  
polarised target*

$$\boxed{+ P_{tg} \left( \sqrt{\epsilon(1+\epsilon)} \sigma_{UL}^{\sin \phi} \sin \phi + \epsilon \sigma_{UL}^{\sin 2\phi} \sin 2\phi \right)}$$

*Target and beam  
longitudinally polarised*

$$\boxed{+ P_b P_{tg} \left( \sqrt{1-\epsilon^2} \sigma_{LL} + \sqrt{\epsilon(1-\epsilon)} \sigma_{LL}^{\cos \phi} \cos \phi \right)}$$

$\epsilon$ : ratio of the fluxes of longitudinally (L) and transversely (T) polarised virtual photons.

$\sigma_i$ : structure functions, related to scattering amplitudes ( $i = L, T, LT, \dots$ ), eg:

$$\frac{d\sigma_L}{dt} = \frac{4\pi\alpha}{k'} \frac{1}{Q^6} \left\{ (1 - \xi^2) |\langle \tilde{H} \rangle|^2 - 2\xi^2 \text{Re}[\langle \tilde{H} \rangle^* \langle \tilde{E} \rangle] - \frac{t'}{4m^2} \xi^2 |\langle \tilde{E} \rangle|^2 \right\}$$

where  $\langle F \rangle \equiv \sum_{\lambda} \int_{-1}^1 dx \mathcal{H}_{\mu'\lambda'\mu\lambda} F$

hard-scattering kernel  $\mathcal{H}_{\mu'\lambda'\mu\lambda}$

GPD  $F$

# Transversity GPDs

- \* For pseudo-scalar mesons, access four chiral-odd (parton helicity-flipping) transversity GPDs (via convolutions of leading-twist GPDs with twist-3 meson DA):  $E_T^q, \tilde{E}_T^q, H_T^q, \tilde{H}_T^q(x, \xi, t)$

Appear in DVMP amplitude when virtual photon has transverse polarisation — not accessible at LT in DVCS.

- \*  $\tilde{E}_T$  can be related to the transverse anomalous magnetic moment:

$$\kappa_T = \int_{-1}^{+1} \tilde{E}_T(x, \xi, t = 0) dx$$

- \* and  $H_T$  to the transversity distribution:  $H_T(x, 0, 0) = h_1(x)$

which describes distribution of transverse partons in a transverse nucleon

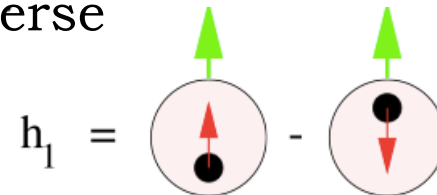

- \* The combination  $\bar{E}_T = 2\tilde{H}_T + E_T$  is related to spatial density of transversely polarised quarks in an unpolarised nucleon.

$$e + p \rightarrow p\pi^0 \quad x_B = 0.36$$

# HEMP @ JLab

## Pseudo-scaler mesons:

- \* Separation of L/T contributions to cross-sections through Rosenbluth-like techniques / simultaneous fits at different kinematics.
- \* Strong transverse contribution observed in charged and neutral pion /  $K^+$  cross-sections: possible access to transversity GPDs.

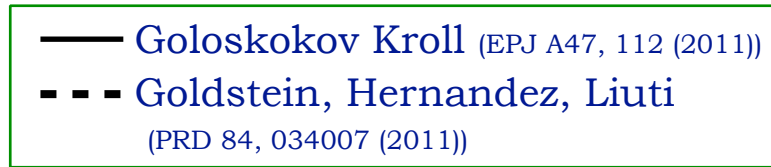

- \* Attempt at GPD flavour-separation using  $\pi^0$  and  $\eta$  BSA.

M. Defurne *et al*, **PRL 117** (2016) 262001

## Vector mesons:

- \* L/T contributions to cross-sections separated by using helicity conservation between virtual photon and meson: strong deviations from leading-twist GPD formalism (higher-twist? evolution effects? meson-size corrections?)
- \* Gluonic GPD  $H_g$  dominates at small  $x$ : gluonic radius.

➔ GPD extraction much cleaner for heavier quarks:  $J/\Psi$

Too close to threshold @ JLab12, ideal for the Electron-Ion Collider!

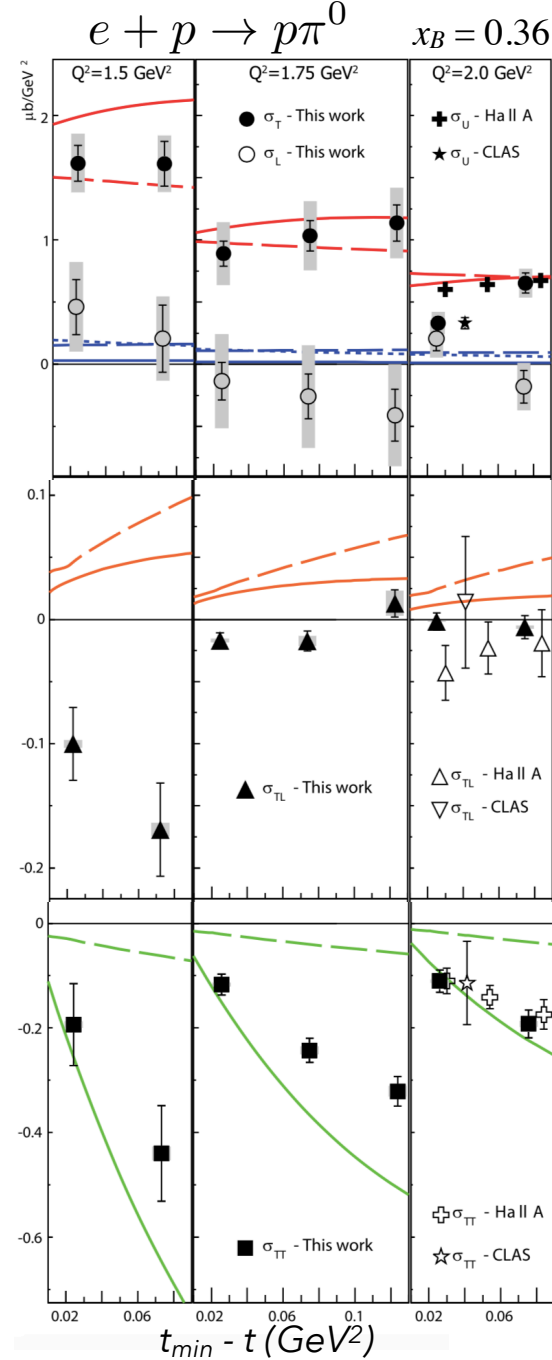

# Meson production at JLab 12 GeV

Cross-sections and spin asymmetries in the 11 GeV kinematics:

- \* Hard exclusive electroproduction of  $\eta$  and  $\pi^0$  (E12-06-108, CLAS12)
- \* Exclusive  $\phi$  meson electroproduction (E12-12-007, CLAS12)
- \* DVCS and neutral pion cross-sections (E12-13-010, Hall C)
- \* Scaling study of the L-T separated pion electroproduction cross-section (E12-07-105, Hall C)
- \* Studies of the L-T separated kaon electroproduction cross-section from 5-11 GeV (E12-09-011, Hall C)
- \* Near-threshold electroproduction of  $J/\Psi$  (E12-12-006, Hall A)
- \* Time-like Compton scattering and  $J/\Psi$  electroproduction (E12-12-001, CLAS12). *Analysis under-way!*



# Summary

## JLab 6 GeV programme:

- \* Indications of higher-twist or higher-orders at play in DVCS: hint of gluons?
- \* Constraints for GPD models: most info on  $Re$  and  $Im$  parts of  $\mathbf{H}_p$  CFF, a little on  $\tilde{\mathbf{H}}_p$ ,  $\mathbf{E}_n$ .
- \* First attempt at tomography with the limited data.
- \* DVCS on a bound protons and a nuclear target (helium).
- \* Significant contributions from transverse photon polarisation: possible access to transversity GPDs in pseudo-scalar meson production.
- \* Vector mesons: GPD interpretation tricky, strong deviations from leading-twist formalism.

## JLab 12 GeV programme:

- \* High precision — separation of DVCS and interference terms: sensitivity to higher twist / higher orders, gluons.
- \* Extensive mapping of a wider kinematic region — strides towards tomography.
- \* Extraction of  $Re$  and  $Im$  parts of  $\mathbf{H}$  CFF,  $\tilde{\mathbf{H}}$ ,  $\mathbf{E}$ , flavour-separation:  $u/d$ .
- \* Access to transversity GPDs.
- \* Many more channels to be measured: meson-production, time-like Compton scattering, double DVCS, photon-meson-pair production: significant constraints on GPDs in the valence region.

*Stay tuned!*



**Thank you!**



**Back-up**

# An abridged history of nucleon structure

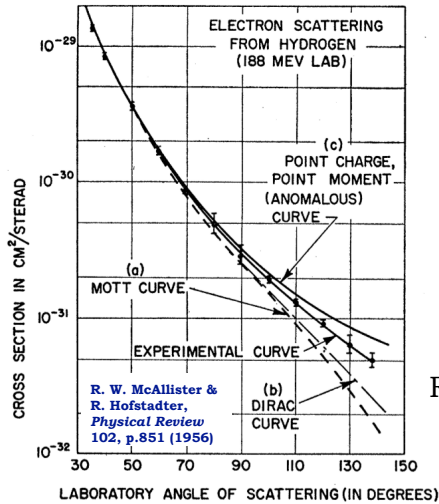

Robert Hofstadter  
1915 - 1990  
(Wikipedia)

**1956:** Elastic scattering at Stanford: the proton has internal structure! *Hofstadter: Nobel Prize 1961.*

**1970s-1990s:** Deep Inelastic Scattering reveals a rich structure: quark-gluon sea, flavour distributions, puzzles of spin and mass... what you see depends on how closely you look!

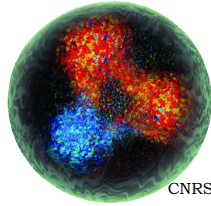

**1960s:** the Quark Model. Nucleons are composed of three valence quarks!  
*Gell-Mann (Nobel Prize 1969), Zweig.*

**1968:** Deep Inelastic scattering at SLAC: scaling observed. The proton consists of point-like charges: partons!  
*Friedman, Kendall, Taylor: Nobel Prize 1990*

**1972:** Theory of QCD developed.



**21st Century:** High-precision imaging of quarks and gluons. 3D tomography of the nucleon: spatial and momentum distributions inside it, mechanical properties of the nucleon, ...

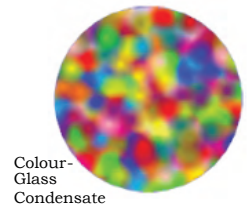
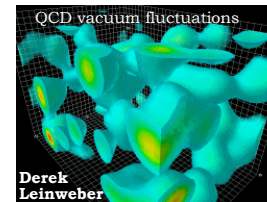
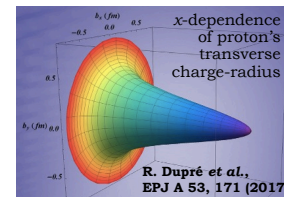
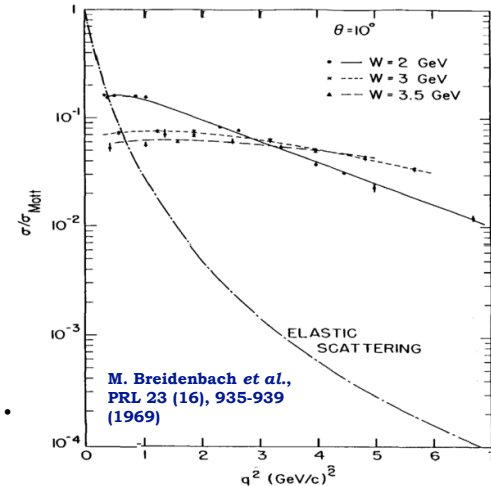

# Nucleon at different scales

## Valence quarks

Jefferson Lab: fixed-target  
electron scattering

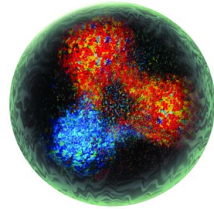

$$0.1 < x_B < 0.7$$

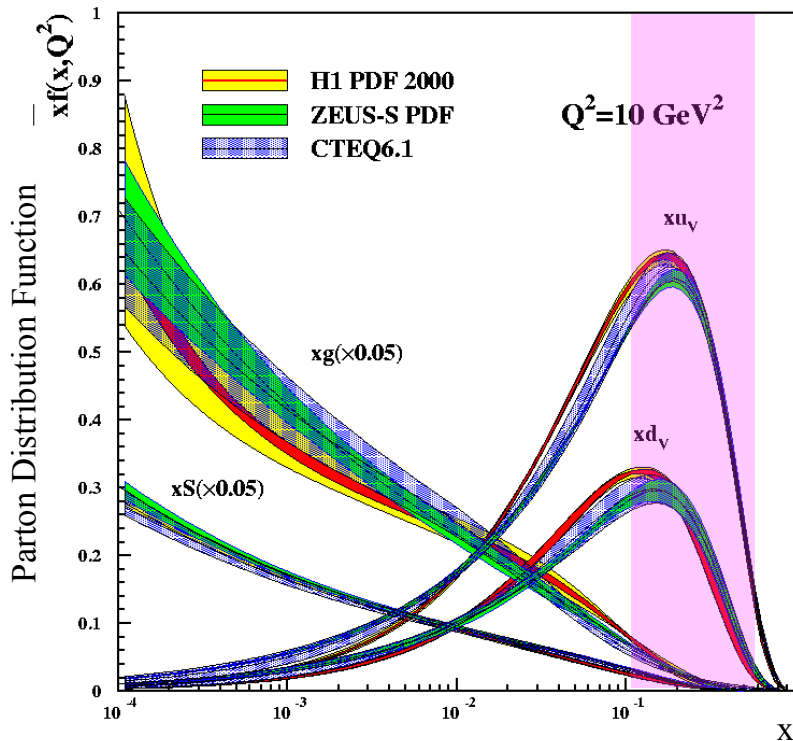

# Nucleon at different scales

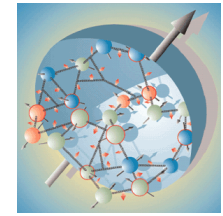

## Valence quarks

**Jefferson Lab**: fixed-target  
electron scattering

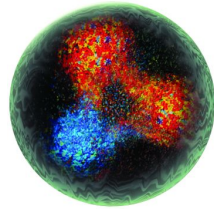

$$0.1 < x_B < 0.7$$

## Sea quarks



**HERMES**: fixed gas-target  
electron/positron scattering

$$0.02 < x_B < 0.3$$

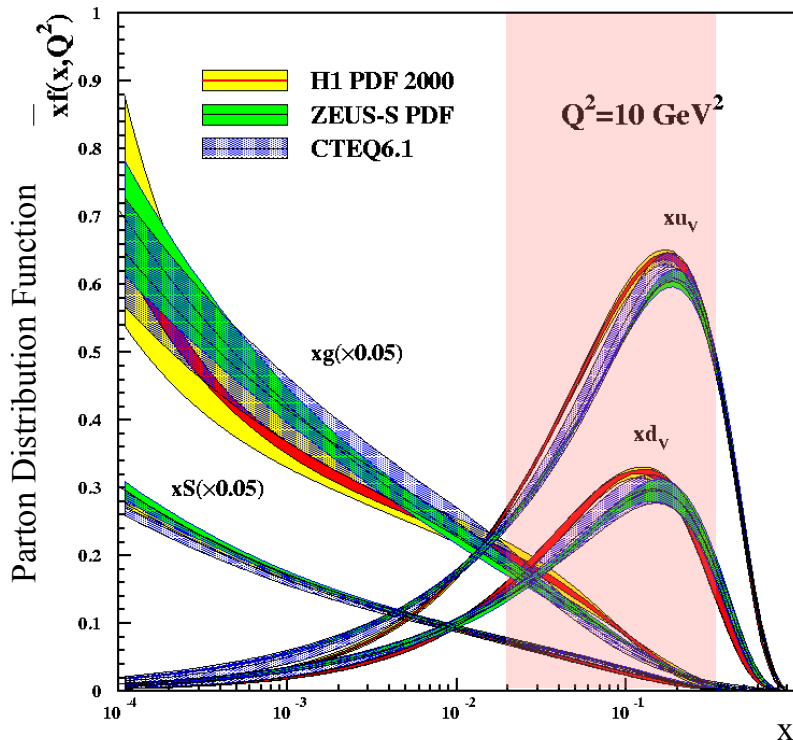

# Nucleon at different scales

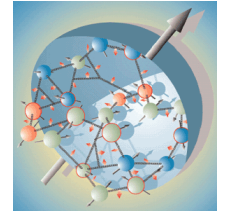

## Valence quarks

**Jefferson Lab**: fixed-target  
electron scattering

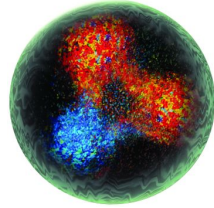

$$0.1 < x_B < 0.7$$

## Sea quarks



**HERMES**: fixed gas-target  
electron/positron scattering

$$0.02 < x_B < 0.3$$



**COMPASS**: fixed-target  
muon scattering

$$0.01 < x_B < 0.1$$

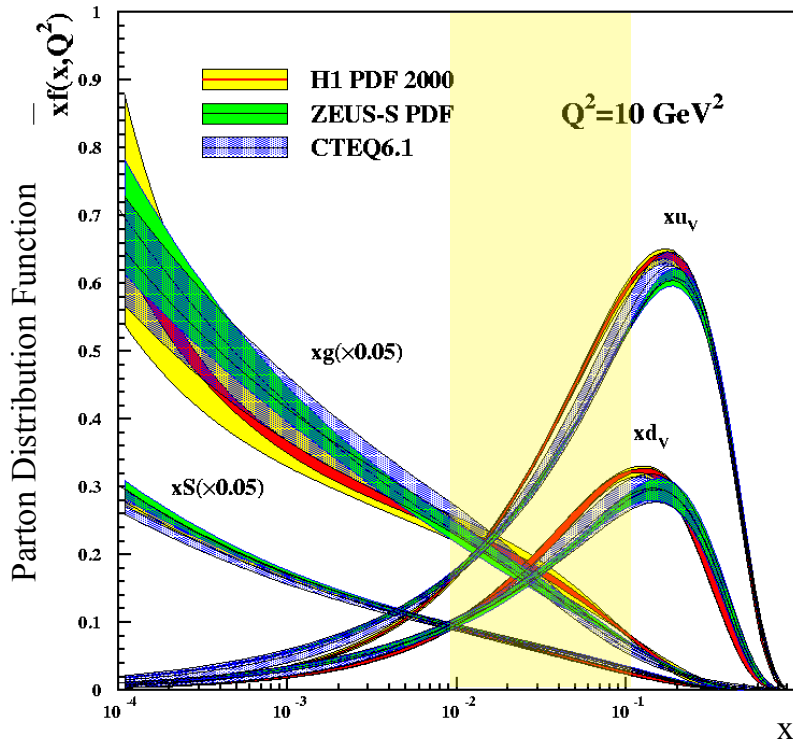

# Nucleon at different scales

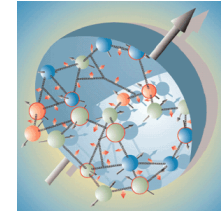

## Valence quarks

**Jefferson Lab**: fixed-target electron scattering

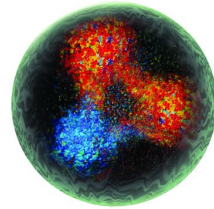

$$0.1 < x_B < 0.7$$

## Sea quarks



**HERMES**: fixed gas-target electron/positron scattering

$$0.02 < x_B < 0.3$$

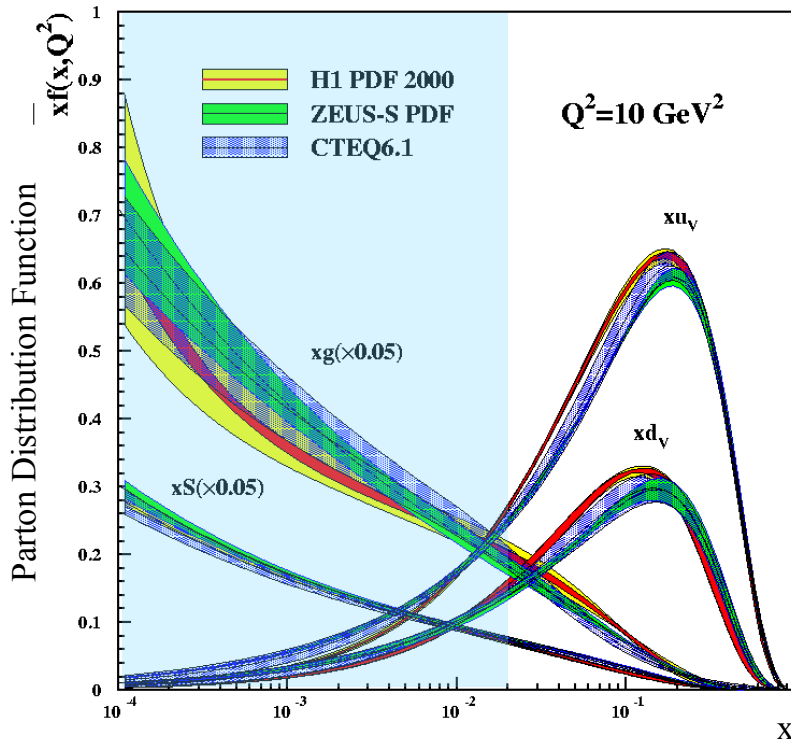

**COMPASS**: fixed-target muon scattering

$$0.01 < x_B < 0.1$$

## The glue

**ZEUS/H1**: electron/positron-proton collider

$$10^{-4} < x_B < 0.02$$

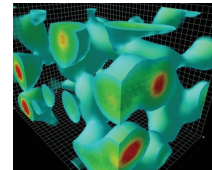

Derek Leinweber





# Nucleon at different scales

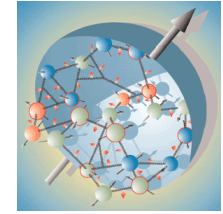

## Valence quarks

**Jefferson Lab**: fixed-target electron scattering

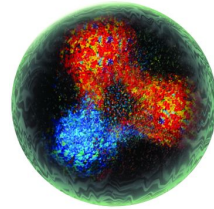

$$0.1 < x_B < 0.7$$

## Sea quarks



**HERMES**: fixed gas-target electron/positron scattering

$$0.02 < x_B < 0.3$$



**COMPASS**: fixed-target muon scattering

$$0.01 < x_B < 0.1$$

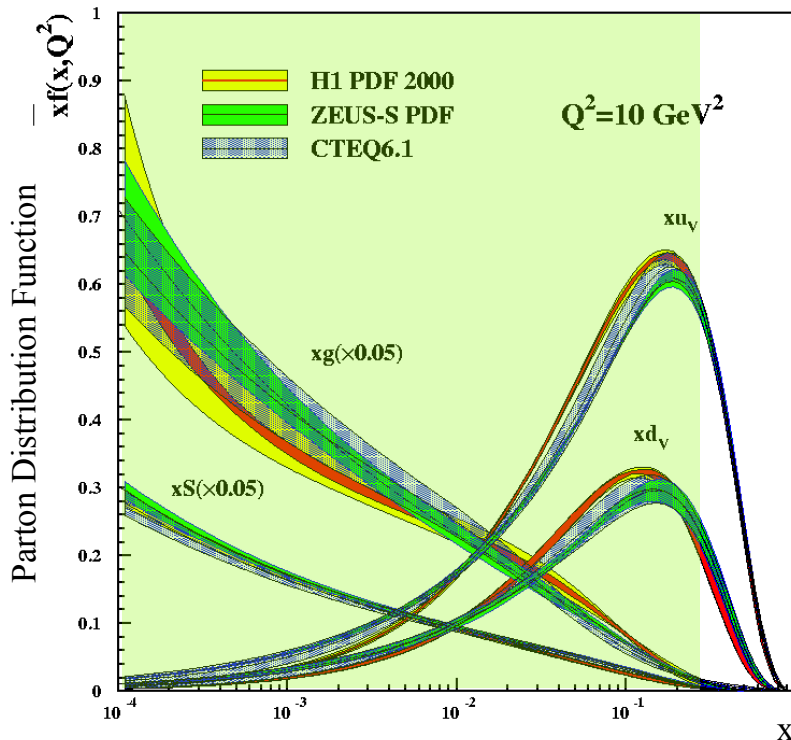

## The glue

**ZEUS/H1**: electron/positron-proton collider

$$10^{-4} < x_B < 0.02$$

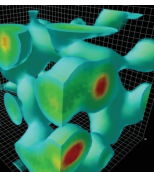

Derek Leinweber

**Electron-ion collider**:  $10^{-4} < x_B < 10^{-1}$

*Luminosity 100 - 1000 times that of HERA*

# Kinematic landscape

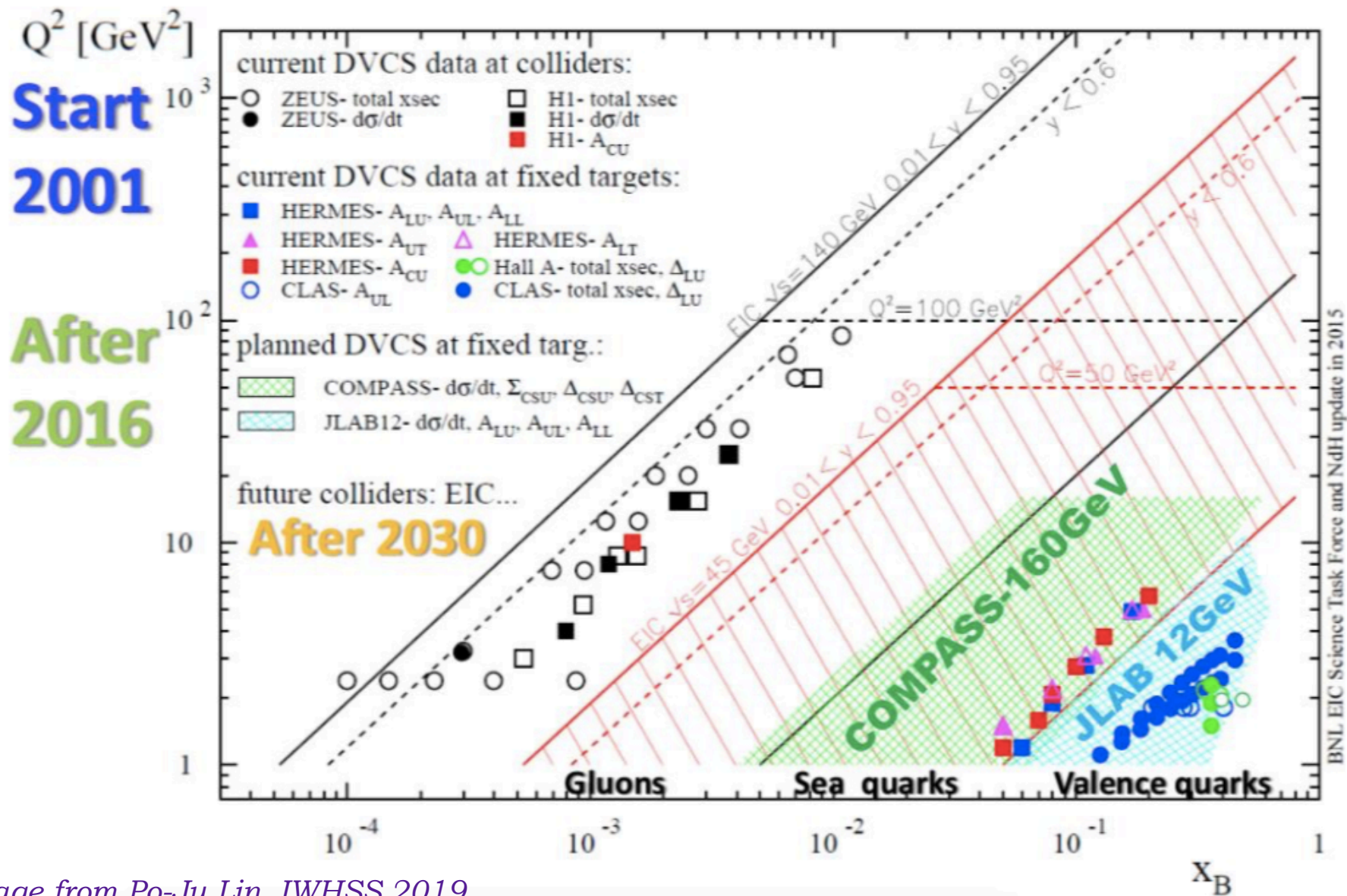

# DVCS in Hall A

Detect electron in the Left  
High Resolution  
Spectrometer (HRS):  
0.01% momentum  
resolution

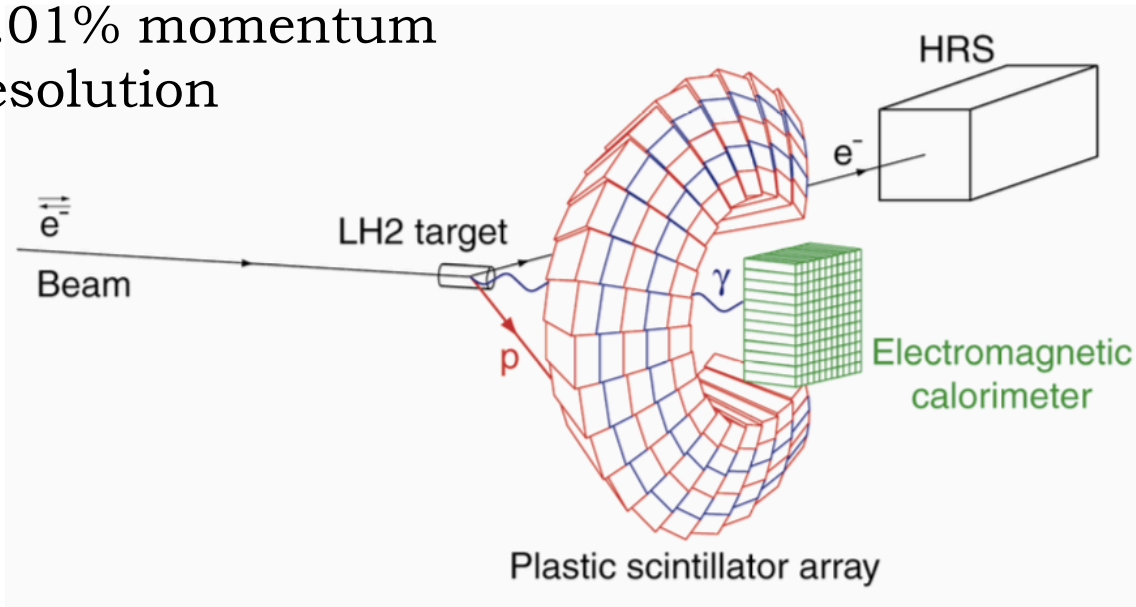

Detect photon in  
PbF<sub>2</sub> calorimeter:  
< 3% energy  
resolution

Plastic scintillator array built for  
proton detection, but not used  
in most recent measurements /  
re-analyses.

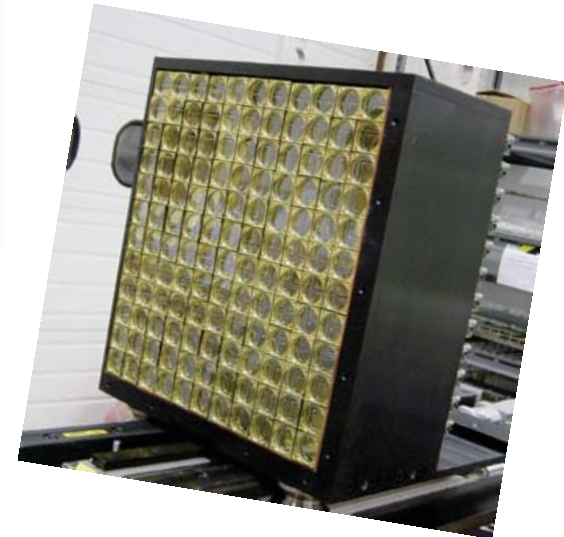

# First DVCS cross-sections in valence region

Hall A

\* E00-110: Hall A, ran in 2004, high precision, narrow kinematic range.

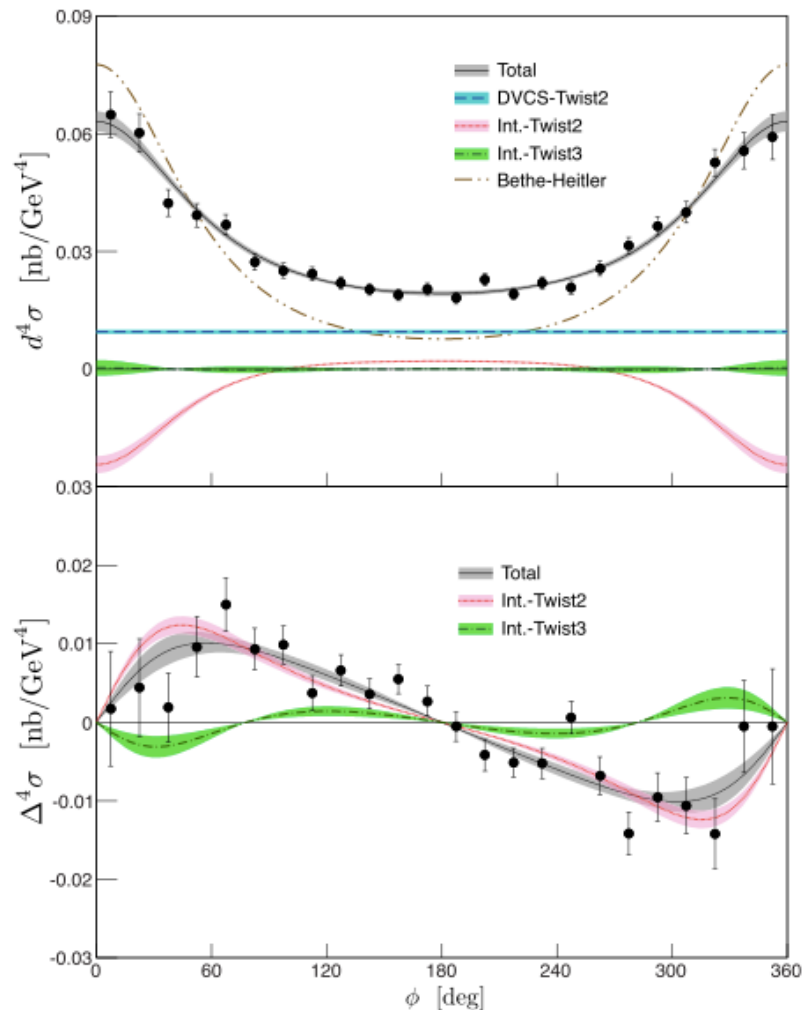

- \* Luminosity =  $10^{37} \text{ cm}^{-2}\text{s}^{-1}$ .
- \* Measure  $Q^2$ -dependence ( $Q^2$ : 1.5, 1.9, 2.3  $\text{GeV}^2$ ) of DVCS-BH cross-sections at fixed  $x_B$  (0.36).
- \* Also  $x_B$  dependence at constant  $Q^2$ .
- \* CFFs show scaling in DVCS: leading twist (twist-2) dominance at this moderate  $Q^2$ .

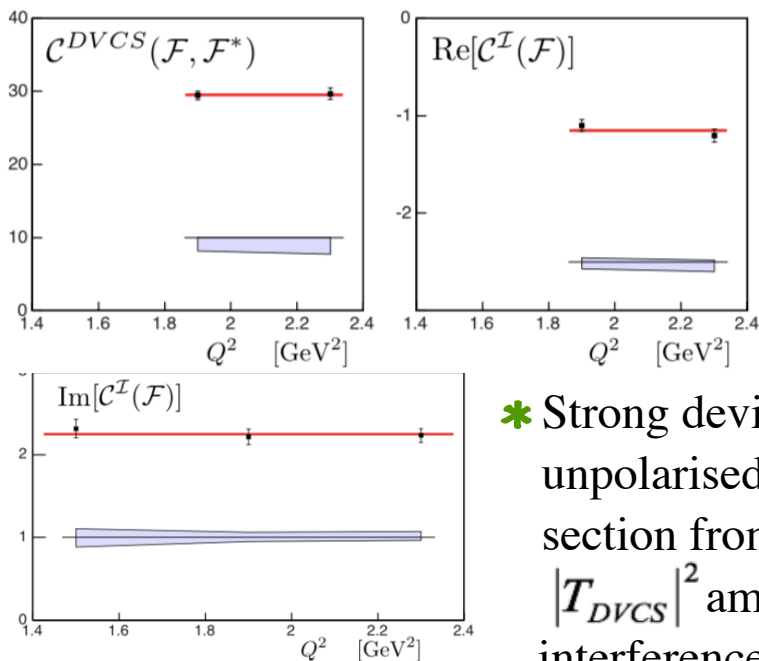

M. Defurne *et al*,  
**PRC 92** (2015)  
055202.

$x_B = 0.36, Q^2 = 2.3 \text{ GeV}^2, -t = 0.32 \text{ GeV}^2$

\* Strong deviation of unpolarised DVCS cross-section from BH: extraction of  $|T_{DVCS}|^2$  amplitude as well as interference terms.

# First DVCS cross-sections in valence region

Hall A

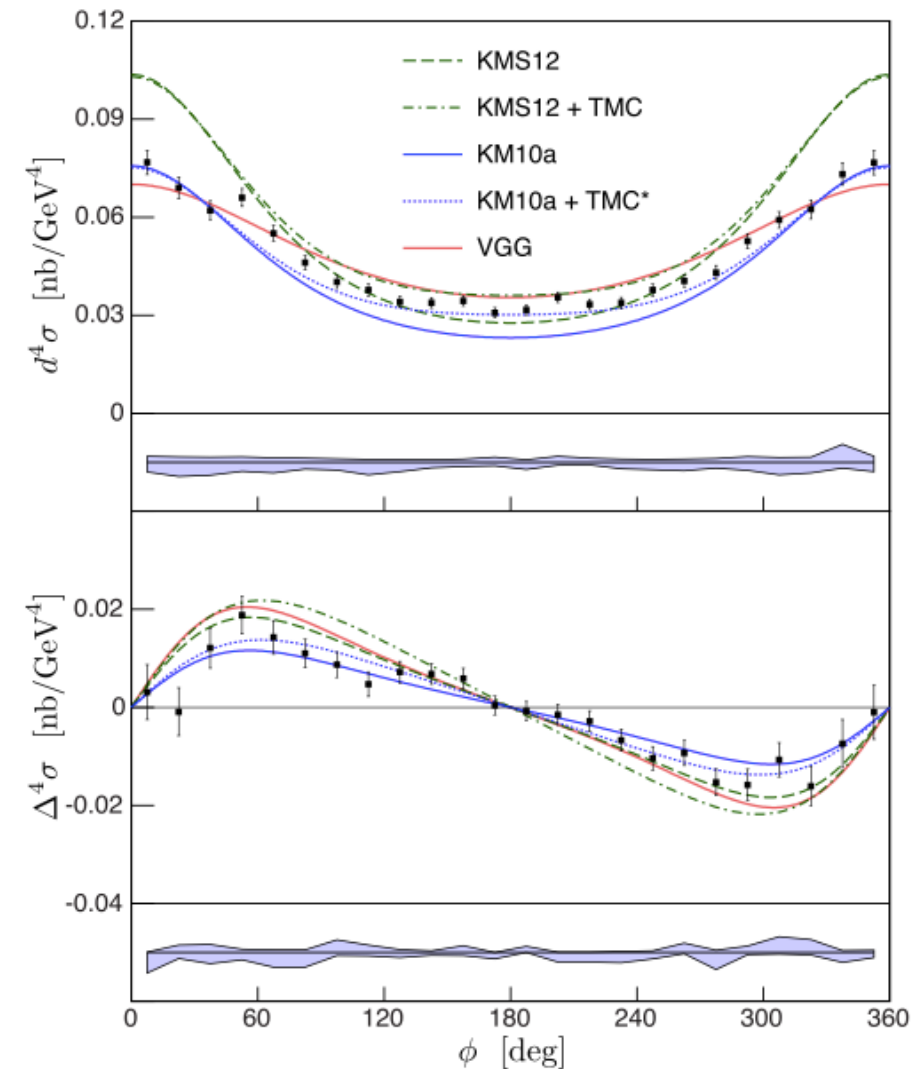

$$x_B = 0.36, Q^2 = 1.9 \text{ GeV}^2, -t = 0.32 \text{ GeV}^2$$

- \* High precision of the data: sensitivity to subtle differences in model predictions.

*VGG model: Vanderhaeghen, Guichon, Guidal*

*KMS model: Kroll, Moutarde, Sabatié*

*KM model: Kumericki, Mueller*

**TMC:** kinematic twist-4 target-mass and finite- $t$  corrections, calculated for proton DVCS and estimated for KMS12.

- \* KMS parameters tuned on very low  $x_B$  meson-production data: not adapted to valence quarks.



TMC\*: TMC extracted from the KMS12 model and applied to KM10a.

- \* TMC improve agreement for KM10a model, especially at  $\phi = 180^\circ$ . Higher-twist effects?

**The devil is in the detail...**

# Here comes the twist...

\* Twist: powers of  $\frac{1}{\sqrt{Q^2}}$  in the DVCS amplitude. Leading-twist (LT) is twist-2.

\* Order: introduces powers of  $\alpha_s$

\* LO requires  $Q^2 \gg M^2$  ( $M$ : target mass)

*Bold assumption for JLab 6 GeV kinematics!*

\* CFFs can be classified according to real and virtual photon helicity:

$\mathcal{F}_{++}$    
↖ helicity of real produced photon   
↙ helicity of virtual incoming photon

- Helicity-conserved CFFs —  $\mathcal{F}_{++}$
- Helicity-flip (transverse) —  $\mathcal{F}_{-+}$
- Longitudinal to transverse flip —  $\mathcal{F}_{0+}$

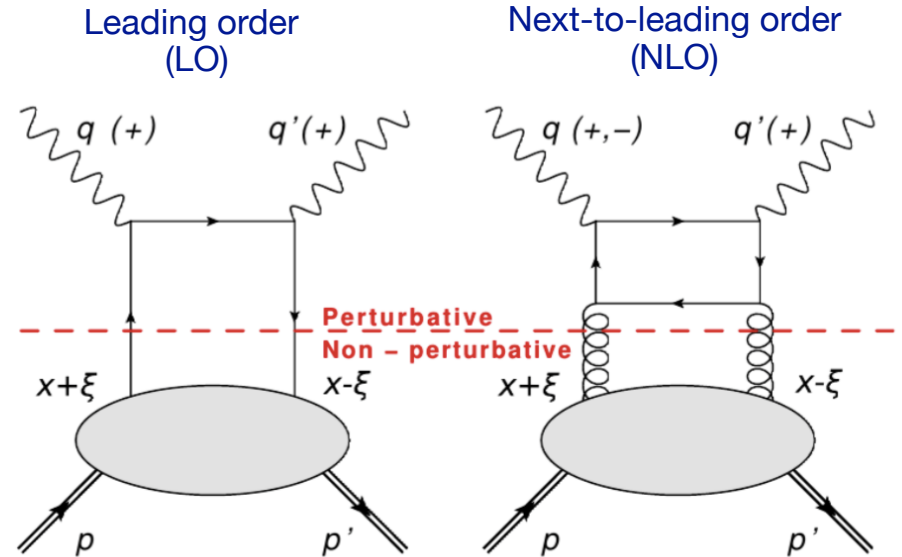

\* CFFs contributing to the scattering amplitude:

- LT in LO: only  $\mathcal{F}_{++}$
- LT in NLO: both  $\mathcal{F}_{++}$  and  $\mathcal{F}_{-+}$
- Twist-3:  $\mathcal{F}_{0+}$

# Here comes the twist...

\* At finite  $Q^2$  and non-zero  $t$  there's ambiguity in defining the light-cone axis:

- Traditional GPD phenomenology uses the Belitsky convention, in plane of  $q$  and  $P$ :  
A. Belitsky *et al*, **Nucl. Phys. B878** (2014), 214
- New, Braun definition using  $q$  and  $q'$ :  
more natural.  
V. Braun *et al*, **Phys. Rev. D89** (2014), 074022

Reformulating CFFs in this frame absorbs most kinematic power corrections (TMC):

$$\begin{aligned}\mathcal{F}_{++} &= \mathbb{F}_{++} + \frac{\chi}{2} [\mathbb{F}_{++} + \mathbb{F}_{-+}] - \chi_0 \mathbb{F}_{0+} \\ \mathcal{F}_{-+} &= \mathbb{F}_{-+} + \frac{\chi}{2} [\mathbb{F}_{++} + \mathbb{F}_{-+}] - \chi_0 \mathbb{F}_{0+} \\ \mathcal{F}_{0+} &= -(1 + \chi) \mathbb{F}_{0+} + \chi_0 [\mathbb{F}_{++} + \mathbb{F}_{-+}]\end{aligned}$$

Belitsky  
CFFs

Braun CFFs

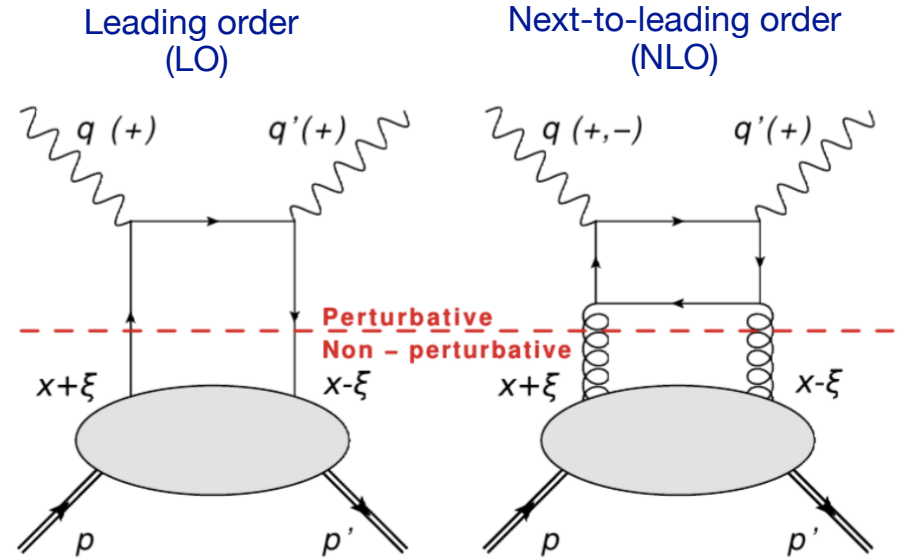

Assuming LO and LT in the Braun frame:

$$\begin{aligned}\mathcal{F}_{++} &= \left(1 + \frac{\chi}{2}\right) \mathbb{F}_{++} && \text{HT/HO contributions} \\ \mathcal{F}_{-+} &= \frac{\chi}{2} \mathbb{F}_{++} && \text{in the Belitsky frame,} \\ \mathcal{F}_{0+} &= \chi_0 \mathbb{F}_{++} && \text{scaled by kinematic} \\ &&& \text{factors } \chi \text{ and } \chi_0.\end{aligned}$$

Non-negligible at the  $Q^2$  and  $x_B$  of the Hall A cross-section measurement:

$$\chi_0 = 0.25, \chi = 0.06 \text{ for } Q^2 = 2 \text{ GeV}^2, x_B = 0.36, t = -0.24 \text{ GeV}^2$$

# Hints of higher twist or higher orders

- \* Including either higher order or higher twist effects (HT) improves the match with data:

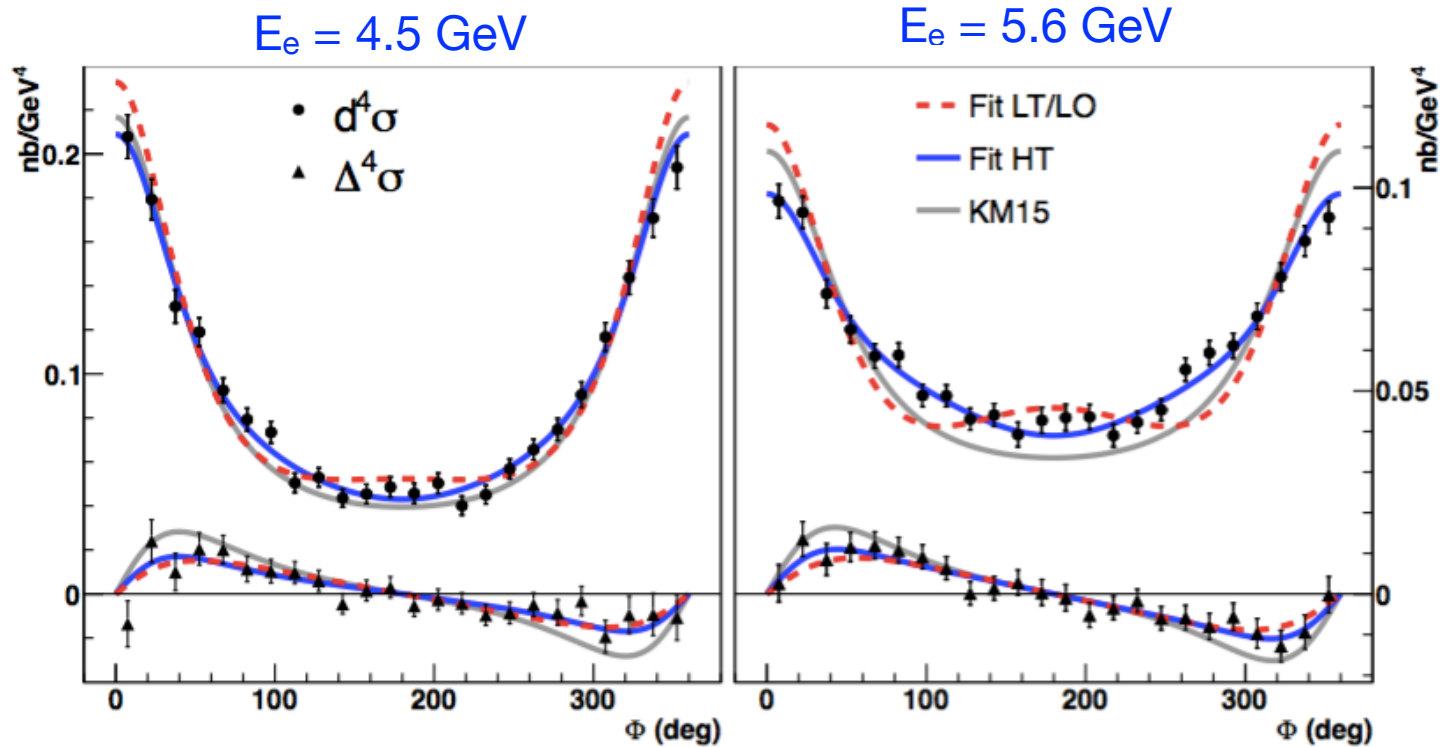

**Higher-order and / or higher-twist terms are important! A glimpse of gluons.**

Wider range of beam energy needed to identify the dominant effect  $\longrightarrow$  **JLab at 11 GeV.**



# Rosenbluth separation of DVCS<sup>2</sup> and BH-DVCS terms

Hall A

- \* Generalised Rosenbluth separation of the DVCS<sup>2</sup> (scales as  $E_e^2$ ) and the BH-DVCS interference (scales as  $E_e^3$ ) terms in the cross-section is possible but NLO and/or higher-twist required: experiment E07-007 @ two beam energies: 4.5 and 5.6 GeV.

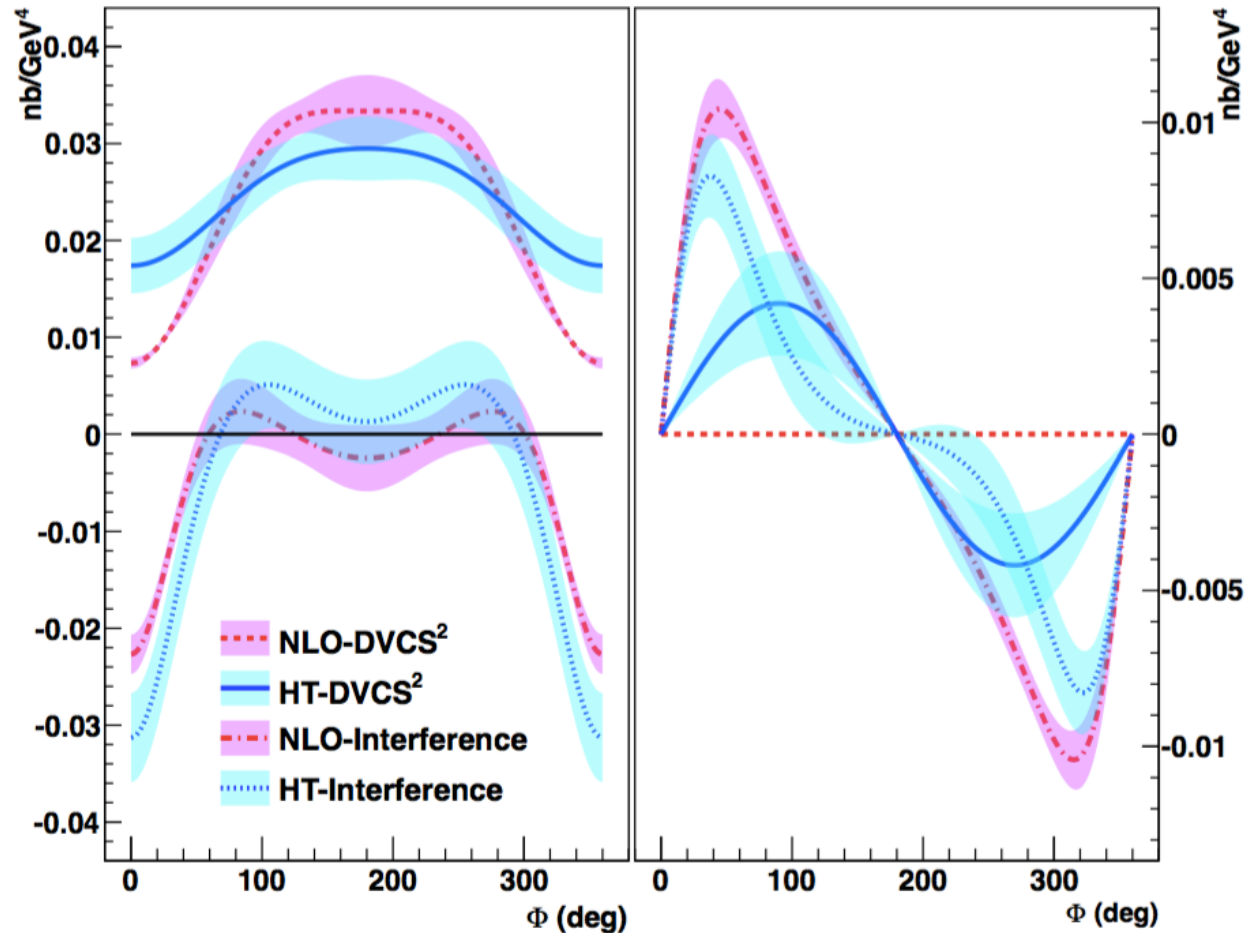

- \* Significant differences between pure DVCS and interference contributions.
- \* Helicity-dependent cross-section has a sizeable DVCS<sup>2</sup> contribution in the higher-twist scenario.
- \* Separation of HT and NLO effects requires scans across wider ranges of  $Q^2$  and beam energy: JLab12!

# Large kinematic coverage: CLAS

- \* Unpolarised DVCS cross-sections and helicity-dependent cross-section differences in a wide kinematic range:

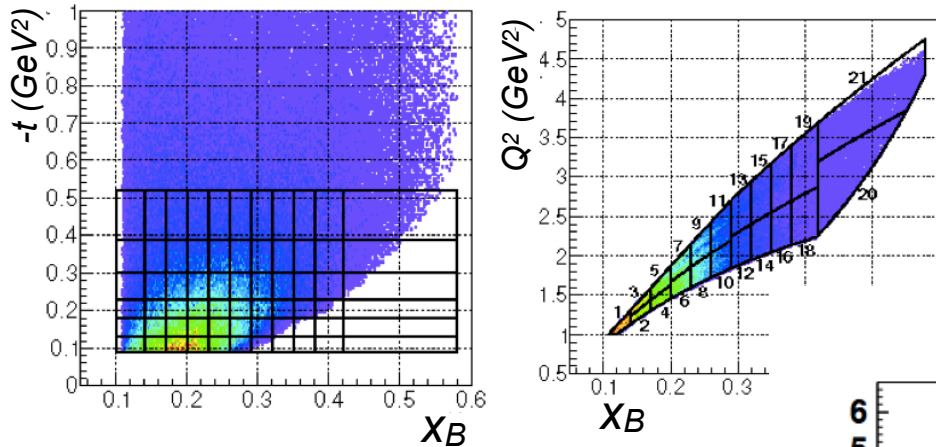

- \* CFFs extracted in a VGG fit.

$$F_{Im}(\xi, t) = F(\xi, \xi, t) \mp F(-\xi, \xi, t)$$

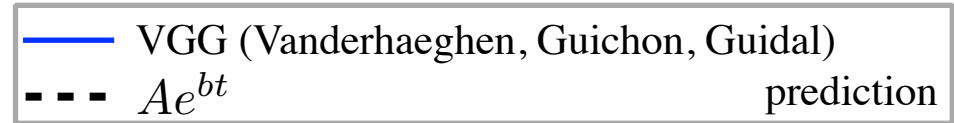

- \* Dominance of GPD  $H$  in unpolarised cross-section.

- \*  $H_{Im}$  slope in  $t$  becomes flatter at higher  $x_B$



Valence quarks at centre, sea quarks spread out towards the periphery.

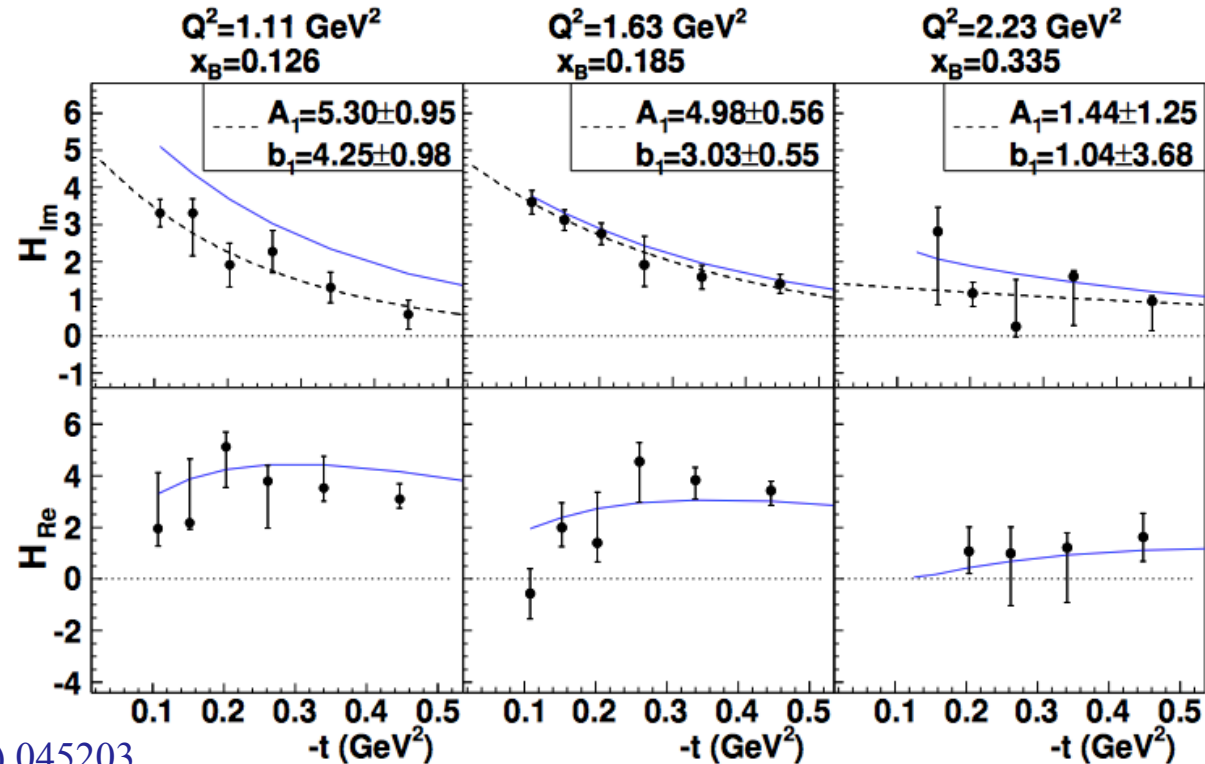

# Which DVCS experiment?

Real parts of CFFs accessible in cross-sections, beam-charge and double polarisation asymmetries,

imaginary parts of CFFs in single-spin asymmetries.

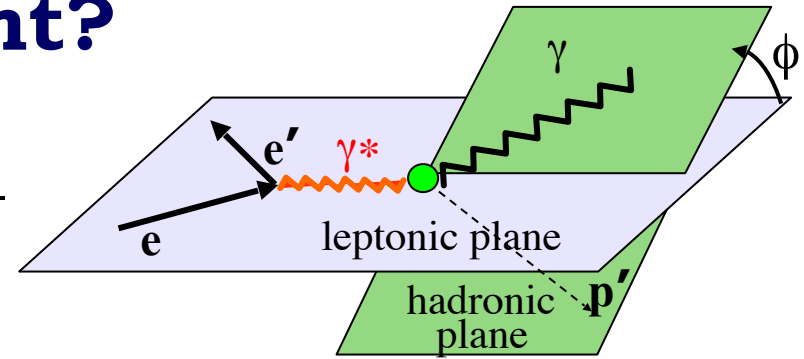

Beam, target polarisation

For example:

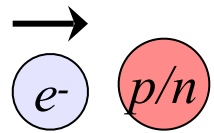

$$\Delta\sigma_{LU} \sim \sin\phi \Im(F_1 H + \xi G_M \tilde{H} - \frac{t}{4M^2} F_2 E) d\phi$$

Proton	Neutron
$\text{Im}\{H_p, \tilde{H}_p, E_p\}$	$\text{Im}\{H_n, H_n, E_n\}$

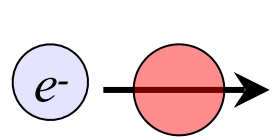

$$\Delta\sigma_{UL} \sim \sin\phi \Im(F_1 \tilde{H} + \xi G_M (H + \frac{x_B}{2} E) - \xi \frac{t}{4M^2} F_2 \tilde{E} + \dots) d\phi$$

$\text{Im}\{H_p, \tilde{H}_p\}$	$\text{Im}\{H_n, E_n, \tilde{E}_n\}$
---------------------------------	--------------------------------------

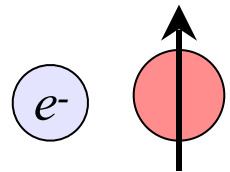

$$\Delta\sigma_{UT} \sim \cos\phi \Im(\frac{t}{4M^2} (F_2 H - F_1 E) + \dots) d\phi$$

$\text{Im}\{H_p, E_p\}$	$\text{Im}\{H_n\}$
-------------------------	--------------------

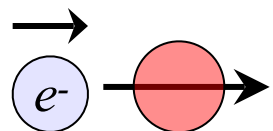

$$\Delta\sigma_{LL} \sim (A + B \cos\phi) \Re(F_1 \tilde{H} + \xi G_M (H + \frac{x_B}{2} E) + \dots) d\phi$$

$\text{Re}\{H_p, \tilde{H}_p\}$	$\text{Re}\{H_n, E_n, \tilde{E}_n\}$
---------------------------------	--------------------------------------

# Beam-spin Asymmetry ( $A_{LU}$ )

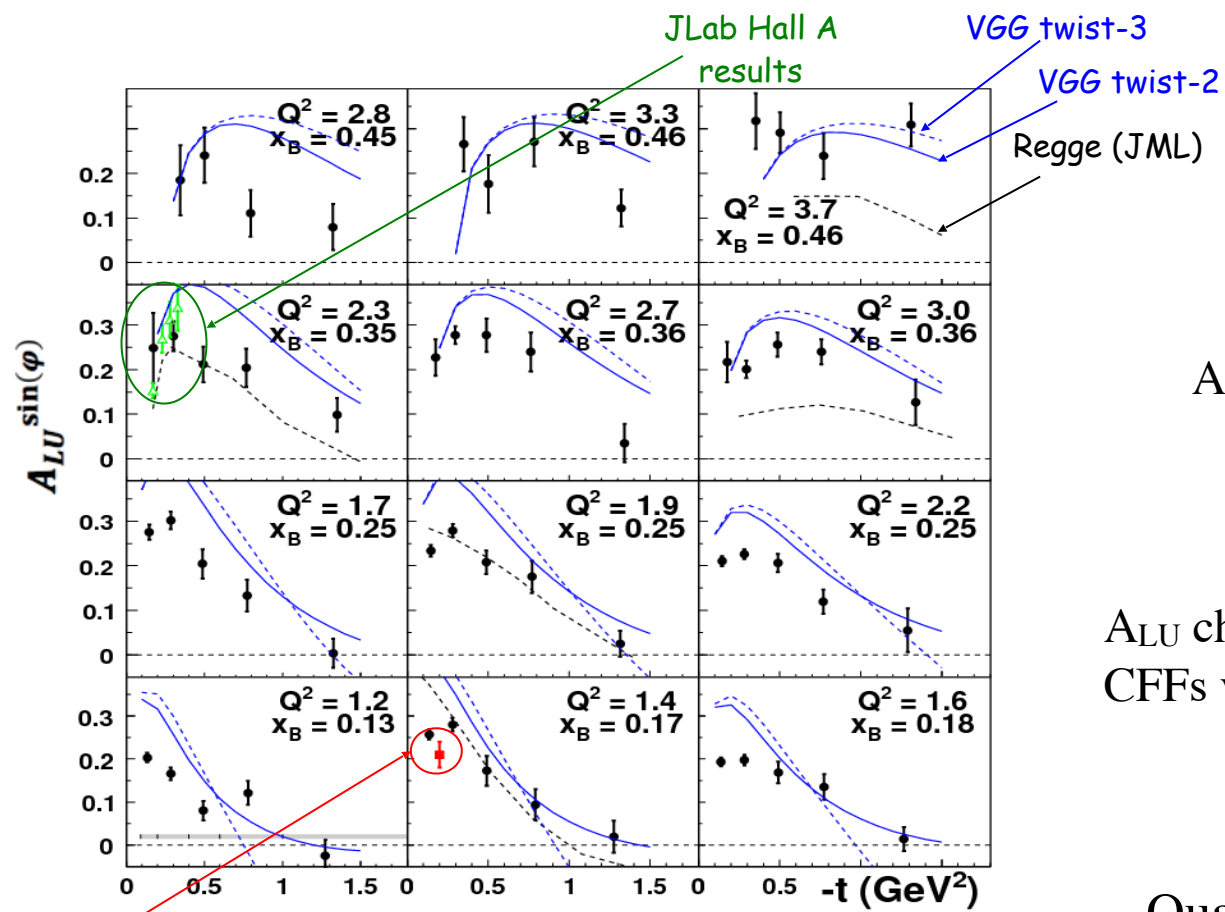
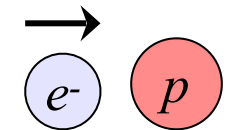

Follows first CLAS measurement:  
 S. Stepanyan *et al* (CLAS), **PRL 87**  
 (2001) 182002

$A_{LU}$  from fit to asymmetry:

$$A_i = \frac{\alpha_i \sin \phi}{1 + \beta_i \cos \phi}$$

$A_{LU}$  characterised by imaginary parts of  
 CFFs via:  $F_1 H + \xi G_M \tilde{H} - \frac{t}{4M^2} E$

Qualitative agreement with models,  
 constraints on fit parameters.

Previous CLAS  
 results

VGG model: Vanderhaeghen, Guichon, Guidal

F.-X. Girod *et al* (CLAS), **PRL 100** (2008) 162002.

# Target-spin Asymmetry ( $A_{UL}$ )

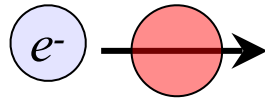
 Follows first CLAS measurement:  
S. Chen *et al* (CLAS),  
**PRL 97** (2006) 072002

$A_{UL}$  from fit to asymmetry:

$$A_i = \frac{\alpha_i \sin \phi}{1 + \beta_i \cos \phi}$$

$A_{UL}$  characterised by imaginary parts of CFFs  
via:

$$F_1 \tilde{H} + \xi G_M \left( H + \frac{x_B}{2} E \right) - \frac{\xi t}{4M^2} F_2 \tilde{E} + \dots$$

High statistics, large kinematic coverage,  
strong constraints on fits, simultaneous fit  
with BSA and DSA from the same dataset.

E. Seder *et al* (CLAS), **PRL 114** (2015) 032001

S. Pisano *et al* (CLAS), **PRD 91** (2015) 052014

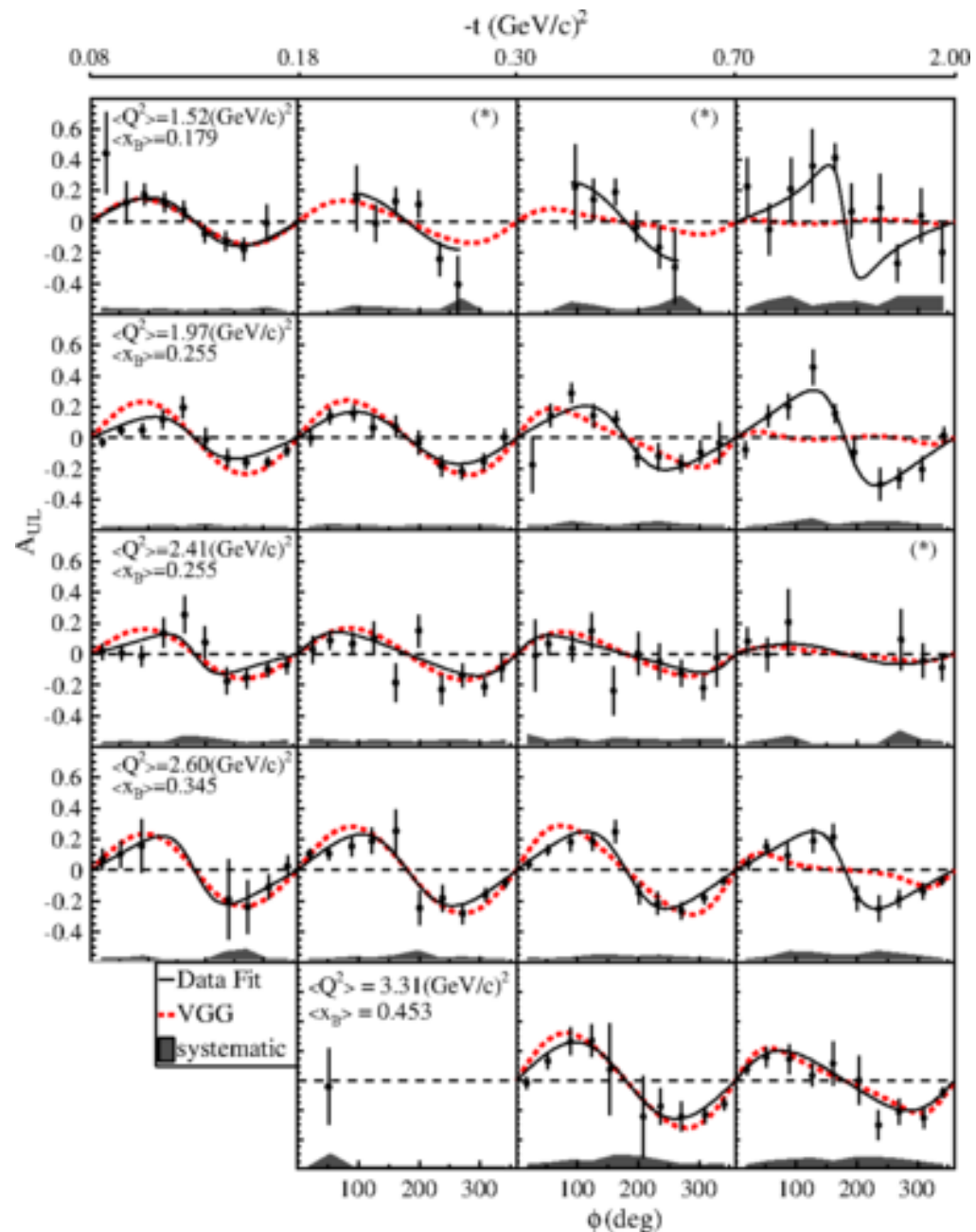

# Beam- and target-spin asymmetries

**CLAS**

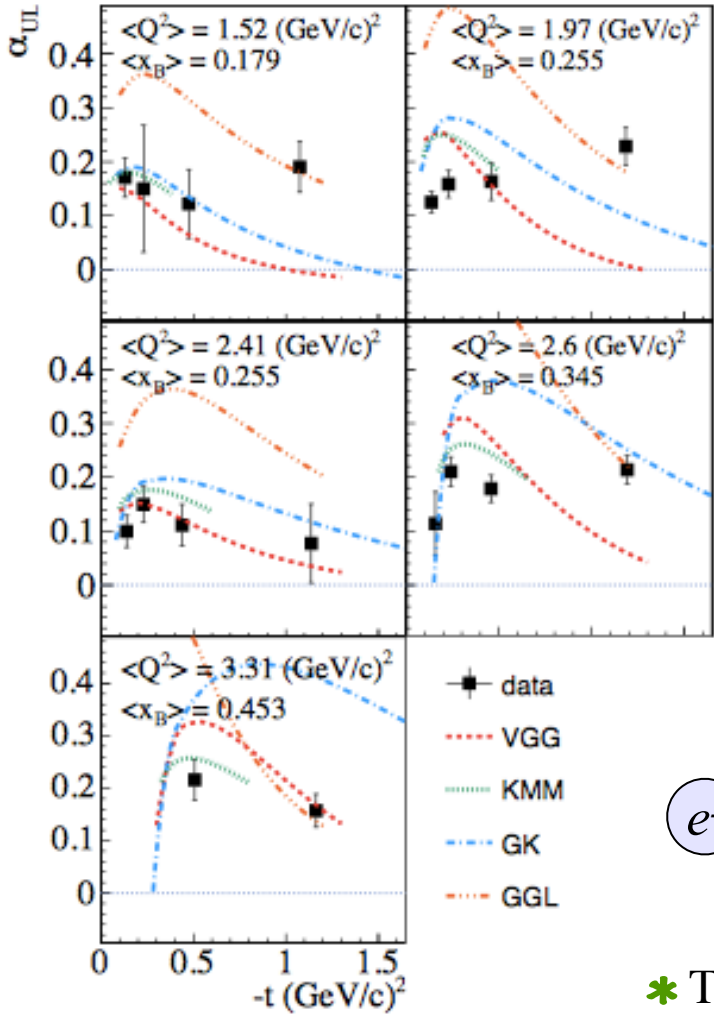
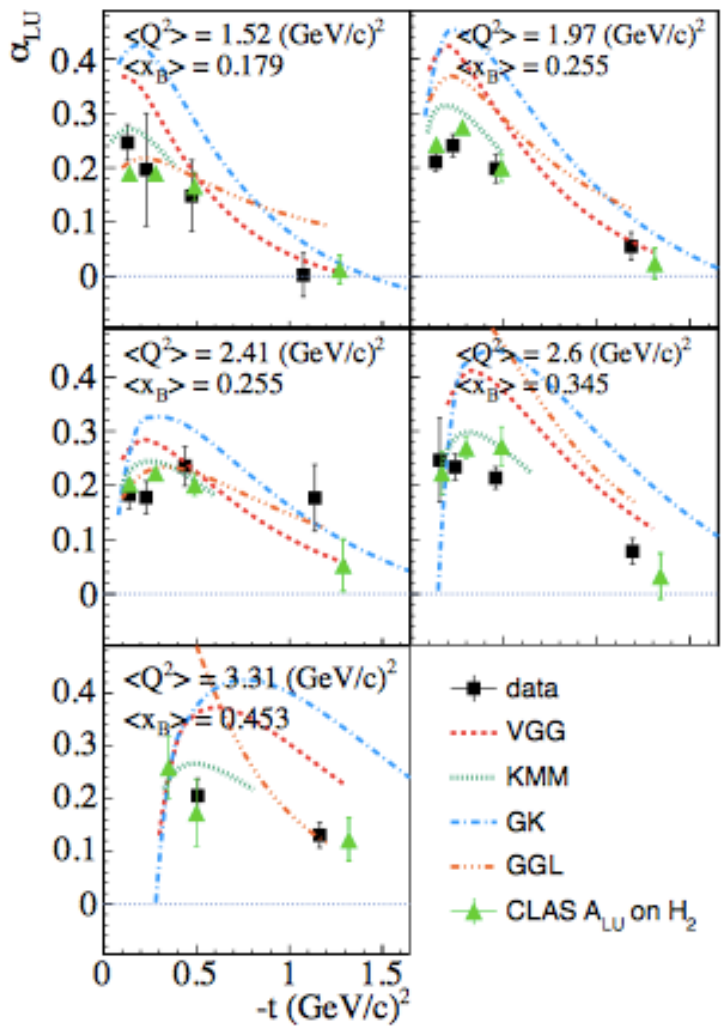

$$A = \frac{\alpha \sin \phi}{1 + \beta \cos \phi}$$

GGL: Goldstein, Gonzalez, Liuti

GK: Kroll, Moutarde, Sabatié

KMM: Kumericki, Mueller, Murray

VGG: Vanderhaeghen, Guichon, Guidal

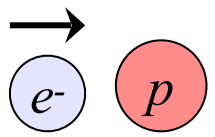

S. Pisano *et al* (CLAS), **PRD 91** (2015) 052014  
 E. Seder *et al* (CLAS), **PRL 114** (2015) 032001

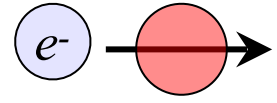

\* TSA shows a flatter distribution in  $t$  than BSA.

# Double-spin asymmetry

At leading twist, double-spin asymmetry (DSA) can be expressed as:

$$A_{LL}(\phi) \sim \frac{c_{0,LP}^{BH} + c_{0,LP}^{\mathcal{I}} + (c_{1,LP}^{BH} + c_{1,LP}^{\mathcal{I}}) \cos \phi}{c_{0,unp}^{BH} + (c_{1,unp}^{BH} + c_{1,unp}^{\mathcal{I}} + \dots) \cos \phi \dots}$$

$$c_{0,LP}^{\mathcal{I}}, c_{1,LP}^{\mathcal{I}} \propto \Re[F_1 \hat{\mathcal{H}} + \xi(F_1 + F_2)(\mathcal{H} + \frac{x_B}{2} \mathcal{E}) - \xi(\frac{x_B}{2} F_1 + \frac{t}{4M^2} F_2) \tilde{\mathcal{E}}]$$

*At CLAS kinematics, leading-twist dominance of these CFFs*

\* Fit function for the phi-dependence of the asymmetry:  $\frac{\kappa_{LL} + \lambda_{LL} \cos \phi}{1 + \beta \cos \phi}$

Shares denominator with BSA and TSA!

If measurements at same kinematics, can do a simultaneous fit.

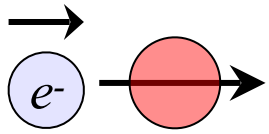

# Double-spin Asymmetry ( $A_{LL}$ )

**CLAS**

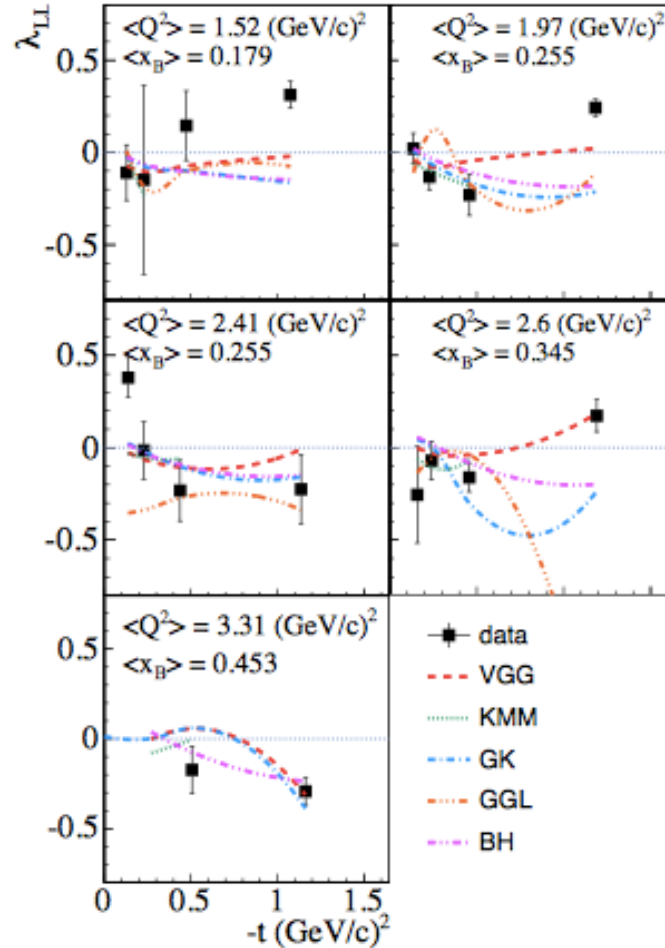
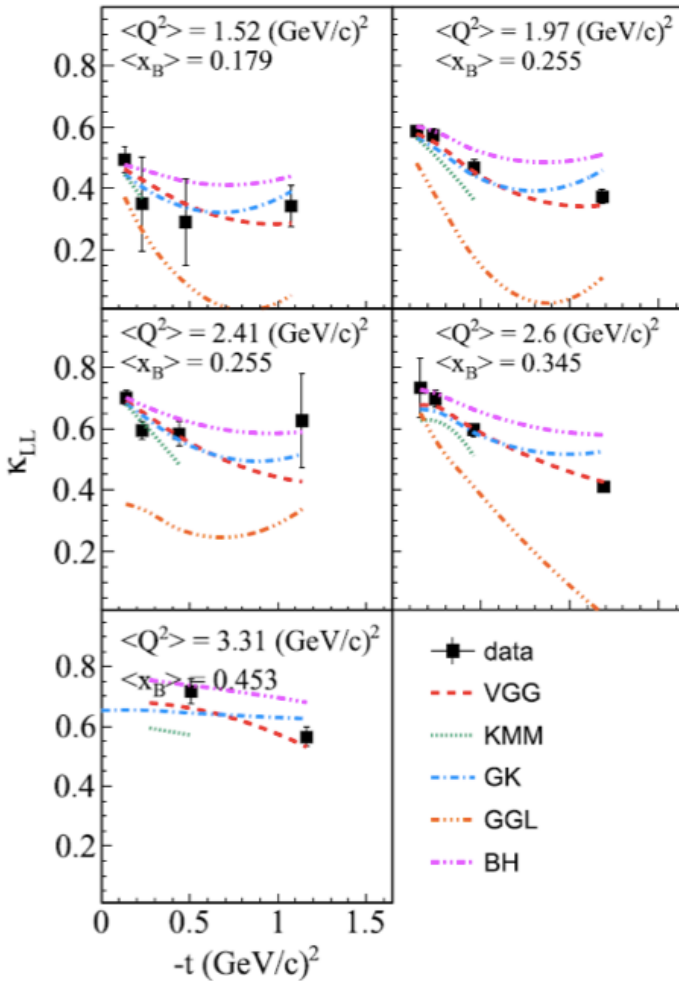

$A_{LL}$  from fit to asymmetry:

$$\frac{\kappa_{LL} + \lambda_{LL} \cos \phi}{1 + \beta \cos \phi}$$

$A_{LL}$  characterised by real parts of CFFs via:

$$F_1 \tilde{H} + \xi G_M \left( H + \frac{x_B}{2} E \right) + \dots$$

- \* Fit parameters extracted from a simultaneous fit to BSA, TSA and DSA.
- \* Constant term dominates and is almost entirely BH.

E. Seder *et al* (CLAS), **PRL 114** (2015) 032001

S. Pisano *et al* (CLAS), **PRD 91** (2015) 052014

CFF extraction from three spin asymmetries at common kinematics.



# Projected sensitivities to $Im(H)$ CFF



$Q^2 = 2.6 \text{ GeV}^2, x_B = 0.23$

$Q^2 = 5.9 \text{ GeV}^2, x_B = 0.35$

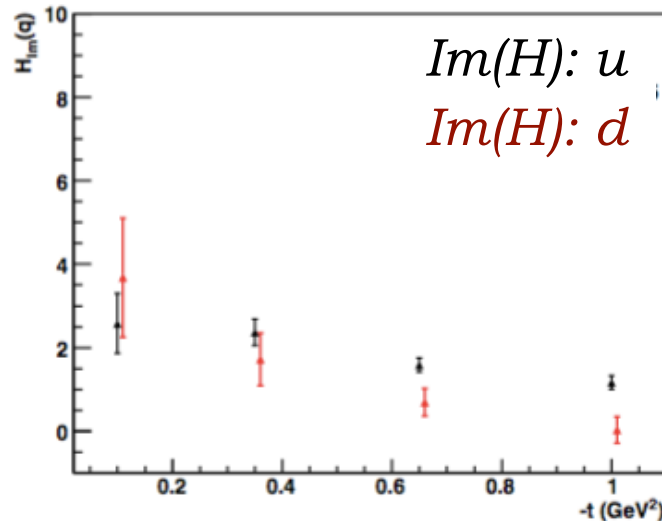
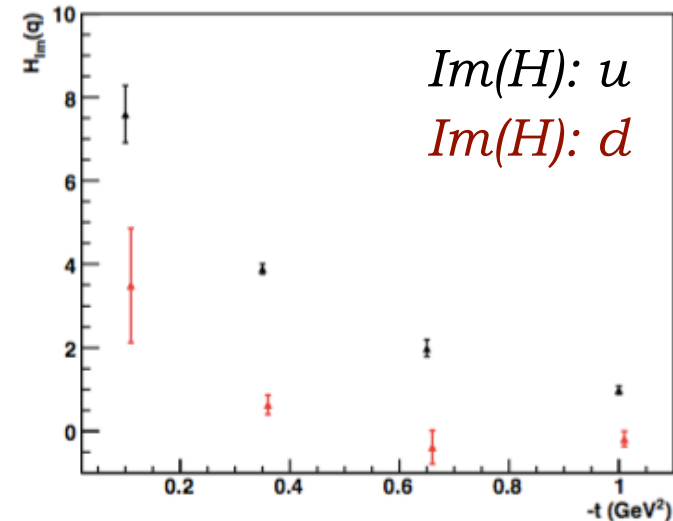
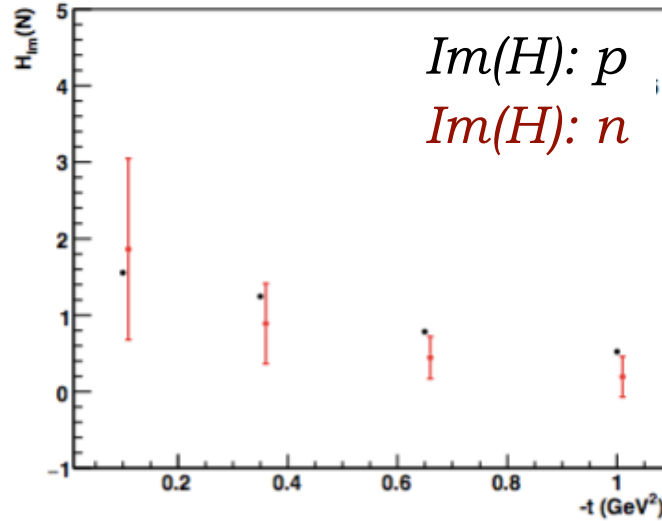
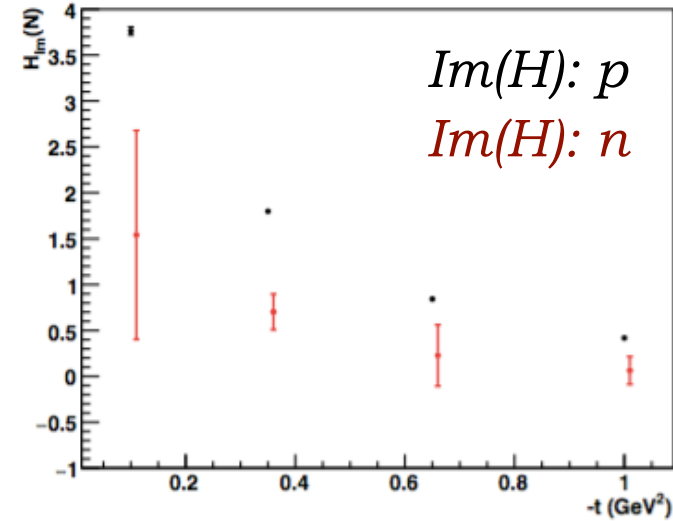

Projections for  $Im(H)$  neutron and proton and up and down CFFs extracted from approved CLAS12 experiments.

*VGG fit (M. Guidal)*

# Projected sensitivities to $Im(E)$ CFF



$Q^2 = 2.6 \text{ GeV}^2, x_B = 0.23$

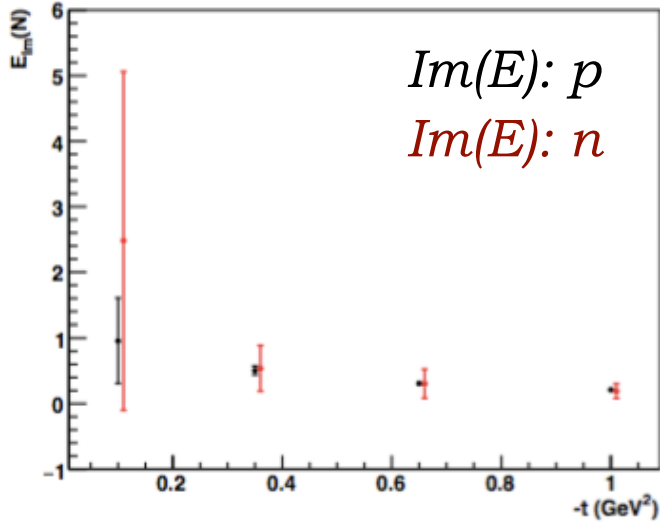

$Q^2 = 5.9 \text{ GeV}^2, x_B = 0.35$

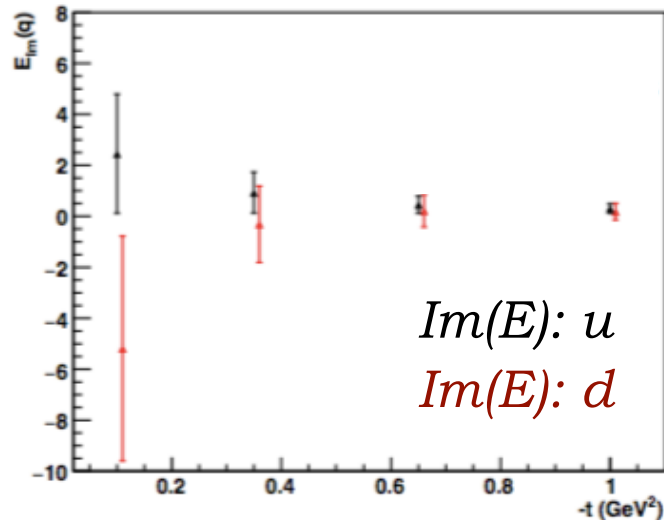
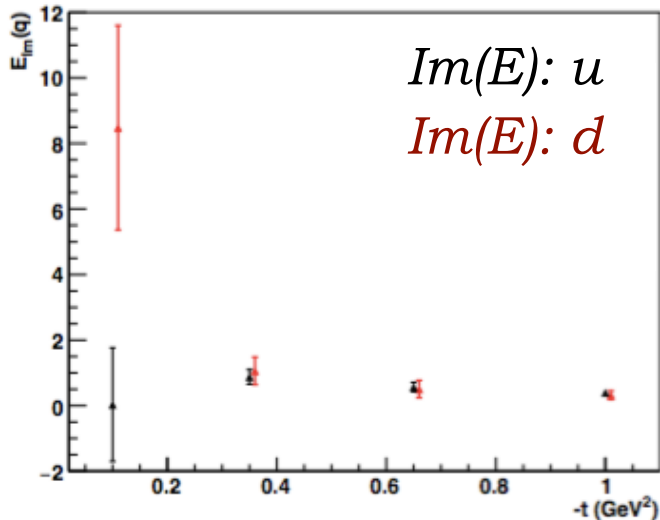
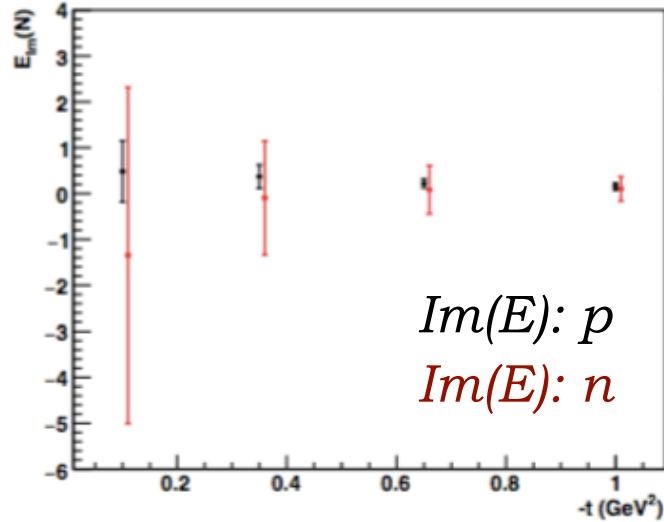

Projections for  $Im(E)$  neutron and proton and up and down CFFs extracted from approved and conditionally-approved CLAS12 experiments.

*VGG fit (M. Guidal)*

# Nuclear GPDs: coherent DVCS on $^4\text{He}$

**CLAS**

\*  $^4\text{He}$  is spin-0, so only one GPD at leading twist,  $\mathcal{H}_A$ .

$$\Re(\mathcal{H}_A) = \mathcal{P} \int_0^1 dx [H_A(x, \xi, t) - H_A(-x, \xi, t)] C^+(x, \xi)$$

$$\Im(\mathcal{H}_A) = -\pi(H_A(\xi, \xi, t) - H_A(-\xi, \xi, t))$$

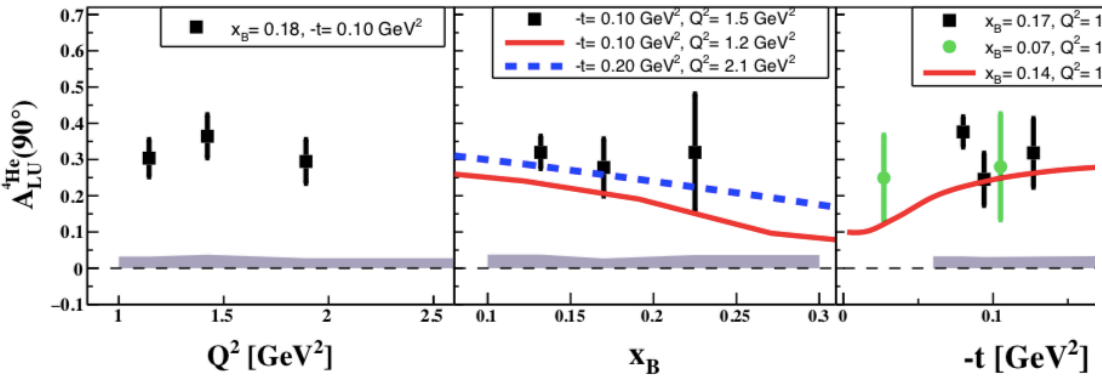

● HERMES  
 — S. Liuti, K. Taneja, PRC72, 032201 (2005)

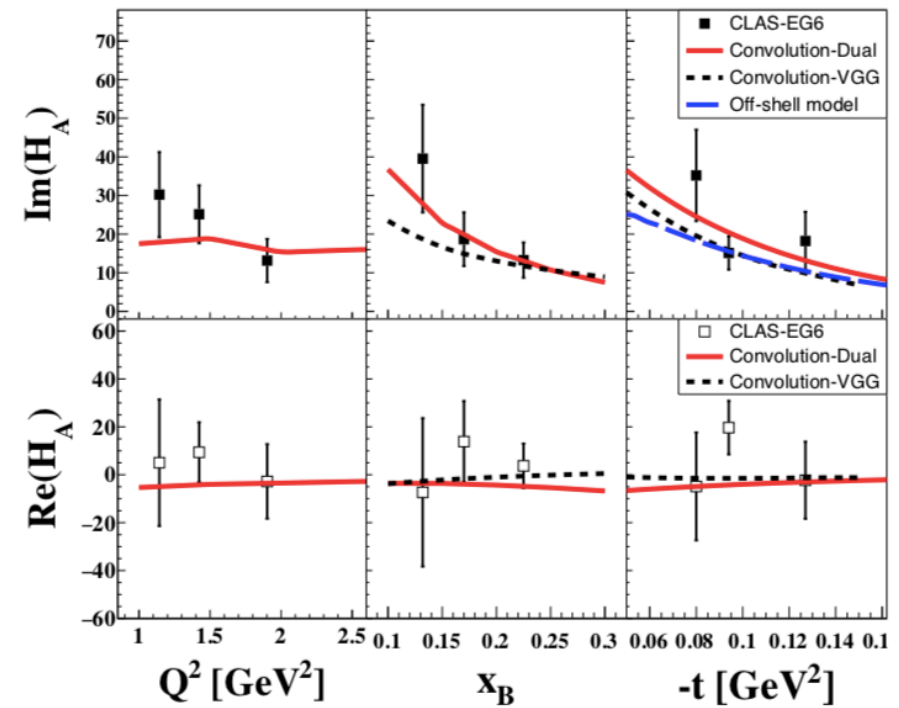

— V. Guzey, PRC78, 025211 (2008)  
 - - - M. Guidal *et al*, PRD72, 054013 (2005)  
 — J. Gonzalez-Hernandez *et al*, PRC88, 065206 (2013)

\* Beam spin asymmetry in coherent DVCS from  $^4\text{He}$ : CLAS and a radial time projection chamber (RTPC) for detection of recoiling helium, data taken in 2009.

\* Paves the way for measurements at 11 GeV.

M. Hattawy *et al*, PRL 119 (2017) 202004.

# Nucleon Tomography from GPDs

- \* At a fixed  $Q^2$ ,  $x_B$ , slope of GPD with  $t$  is related, via a Fourier Transform, to the transverse spatial spread.

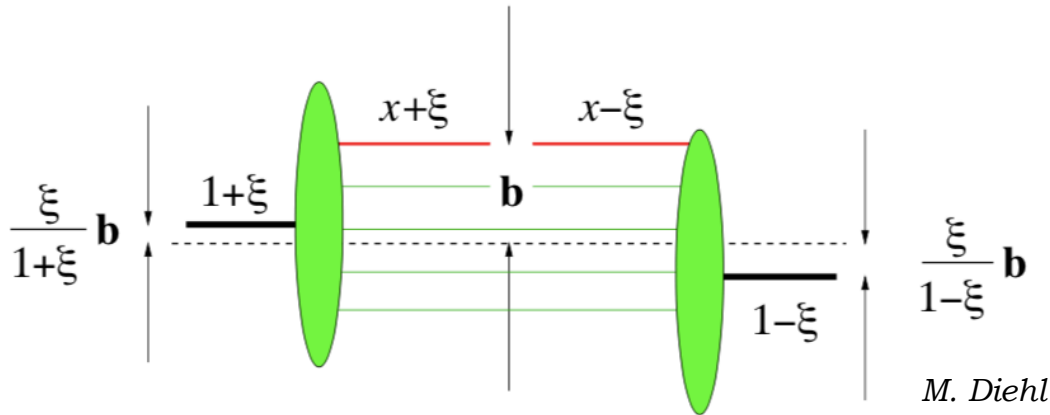
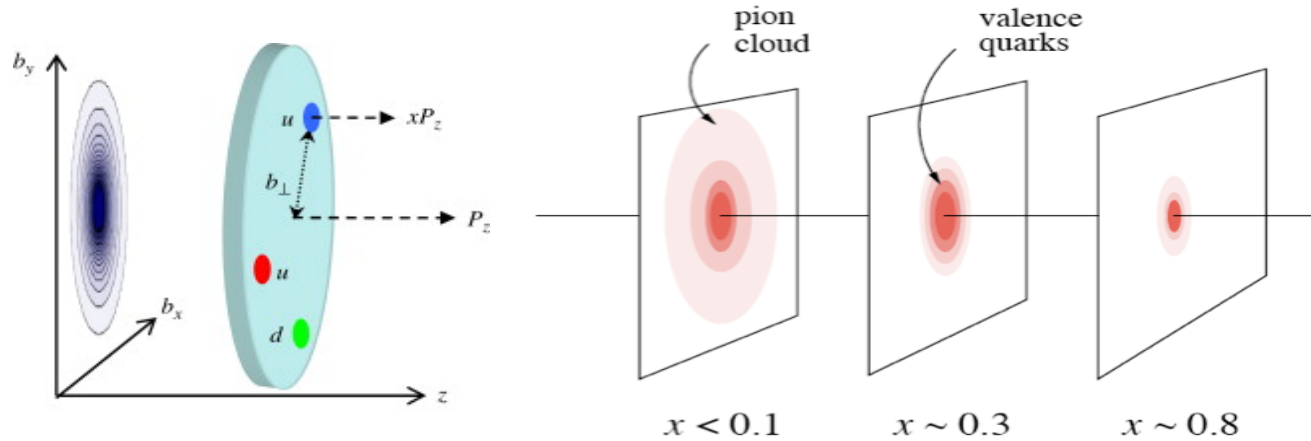

M. Diehl

*Formally, the radial separation,  $\mathbf{b}$ , between the struck parton and the centre of momentum of the remaining spectators.*

- \* Experimentally, fit the  $t$ -dependence of structure functions or CFFs with an exponential.

$$\text{eg: } \frac{d\sigma_U}{dt} = Ae^{Bt}$$

# GPDs and nucleon spin

$$J_N = \frac{1}{2} = \frac{1}{2} \Sigma_q + L_q + J_g$$

\* Ji's relation:  $J^q = \frac{1}{2} - J^g = \frac{1}{2} \int_{-1}^1 dx \left\{ H^q(x, \xi, 0) + E^q(x, \xi, 0) \right\}$

Second Mellin moments of the GPDs contain information on the total angular momentum carried by quarks.

Note that the contribution from GPD  $H$  is given by the quark momentum, already known from PDFs:

$$2J^q = \int_0^1 dx x [q(x) + \bar{q}(x)] + \int_{-1}^{+1} dx x E^q(x, 0, 0)$$

# Compton Form Factors in DVCS

Experimentally, DVCS amplitude is proportional to Compton Form Factors (CFFs) — sums of GPD integrals over  $x$ :

$$\int_{-1}^1 dx F(\mp x, \xi, t) \left[ \frac{1}{x - \xi + i\epsilon} \pm \frac{1}{x + \xi - i\epsilon} \right]$$

*GPD*

*Plus sign for unpolarised GPDs, minus for polarised.*

Can be decomposed into real and imaginary parts:

*Cauchy's principal value integral*

$$\Re \mathcal{F} = \mathcal{P} \int_{-1}^1 dx \left[ \frac{1}{x - \xi} \mp \frac{1}{x + \xi} \right] F(x, \xi, t)$$

**\*** Both parts are accessible in different experimental observables

$$\Im \mathcal{F}(\xi, t) = -\pi [F(\xi, \xi, t) \mp F(-\xi, \xi, t)]$$

# Other reactions to get at GPDs

- \* **Time-like Compton scattering:** virtual photon is time-like. At leading order, access same integrals of GPDs. At higher orders, they differ.

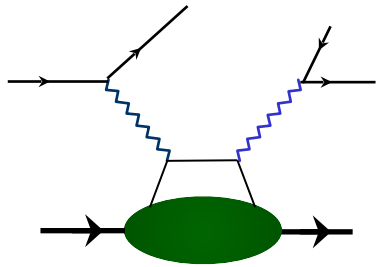
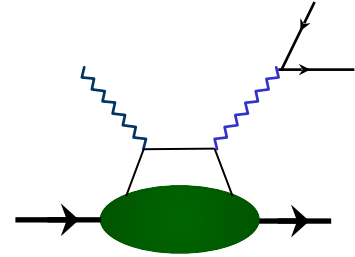

- \* **Double Deeply Virtual Compton scattering:** two virtual photons: the second vertex provides a second variable  $Q'^2$ . This allows direct access to  $x$ , but cross-sections are suppressed by another factor of  $\alpha$ .

- \* **Deeply Virtual Meson Production:** the meson vertex provides flavour information. Amplitude now depends on GPDs and the meson Distribution Amplitudes. In light mesons, more sensitive to higher order and higher twist.

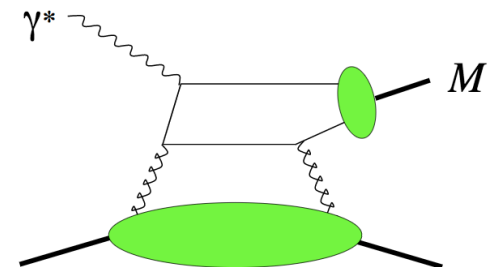
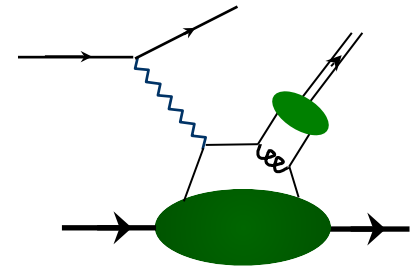

In vector mesons, gluon GPDs appear at lowest order!

# Nucleon Tomography from GPDs

- \* Flavour separation is possible in DVCS using different targets (proton and neutron), and in DVMP with different mesons.

For example, compare measurements of  $\pi^0$  and  $\eta$  DVMP:

$$H_T^{\pi^0} = (e_u H_T^u - e_d H_T^d) / \sqrt{2}, \quad H_T^\eta = (e_u H_T^u + e_d H_T^d) / \sqrt{6},$$

$$\bar{E}_T^{\pi^0} = (e_u \bar{E}_T^u - e_d \bar{E}_T^d) / \sqrt{2}, \quad \bar{E}_T^\eta = (e_u \bar{E}_T^u + e_d \bar{E}_T^d) / \sqrt{6}.$$

*Up-quark charge*

*(Goloskokov-Kroll model)*

- \* Different GPDs represent different aspects of the parton distributions: EM charge, axial charge, transversity, etc....
- \* Sensitivity to gluon distributions through gluon GPDs.

Particularly cleanly accessible for heavier  $q$ :  $J/\Psi$



# Extracting asymmetries

Number of DVCS/BH events for each kinematic bin:

$$N^{bt} = (1 - B_{\pi^0}^{bt}) \cdot \frac{N_{ep\gamma}^{bt}}{FC^{bt}}$$

*Polarisation state of beam, target*

*Background due to  $\pi^0$  contamination*

*Number of detected events in identified reaction*

*Normalisation by beam current (in Faraday Cup)*

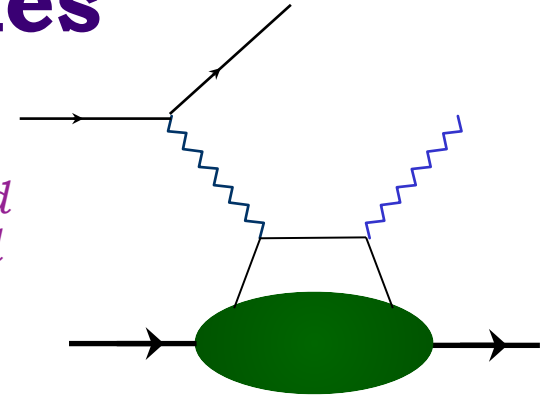

\* Beam-spin asymmetry:

$$A_{LU} = \frac{P_t^- (N^{++} - N^{-+}) + P_t^+ (N^{+-} - N^{--})}{P_b (P_t^- (N^{++} + N^{-+}) + P_t^+ (N^{+-} + N^{--}))}$$

\* Target-spin asymmetry:

*Beam, target polarisation*

$$A_{UL} = A_{UL}^{\text{lab}} + c_{A_{UT}} \leftarrow \text{Correction for electron / virtual photon axes}$$

$$A_{UL}^{\text{lab}} = \frac{N^{++} + N^{-+} - N^{+-} - N^{--}}{D_f (P_t^- (N^{++} + N^{-+}) + P_t^+ (N^{+-} + N^{--}))}$$

*Dilution factor due to unpolarised background*

\* Double-spin asymmetry:

$$A_{LL} = A_{LL}^{\text{lab}} + c_{A_{LT}}$$

$$A_{LL}^{\text{lab}} = \frac{N^{++} + N^{--} - N^{+-} - N^{-+}}{P_b \cdot D_f (P_t^- (N^{++} + N^{-+}) + P_t^+ (N^{+-} + N^{--}))}$$

# The DVCS/BH amplitude

$$\mathcal{T}^2 = |\mathcal{T}_{\text{BH}}|^2 + |\mathcal{T}_{\text{DVCS}}|^2 + \mathcal{I} \quad \leftarrow \text{Interference term for DVCS/BH}$$

$$|\mathcal{T}_{\text{BH}}|^2 = \frac{e^6}{x_B^2 y^2 (1 + \epsilon^2)^2 t \mathcal{P}_1(\phi) \mathcal{P}_2(\phi)} \left[ c_0^{\text{BH}} + \sum_{n=1}^2 c_n^{\text{BH}} \cos n\phi + s_1^{\text{BH}} \sin \phi \right]$$

$$|\mathcal{T}_{\text{DVCS}}|^2 = \frac{e^6}{y^2 Q^2} \left\{ c_0^{\text{DVCS}} + \sum_{n=1}^2 [c_n^{\text{DVCS}} \cos n\phi + s_n^{\text{DVCS}} \sin n\phi] \right\}$$

$$\mathcal{I} = \frac{e^6}{x_B y^3 t \mathcal{P}_1(\phi) \mathcal{P}_2(\phi)} \left\{ c_0^{\mathcal{I}} + \sum_{n=1}^3 [c_n^{\mathcal{I}} \cos n\phi + s_n^{\mathcal{I}} \sin n\phi] \right\}$$

*Intermediate lepton propagators*

*Coefficients depending on Compton Form Factors*

# From asymmetries to CFFs

At leading twist, beam-spin asymmetry (BSA) can be expressed as:

$$A_{\text{LU}}(\phi) \sim \frac{s_{1,\text{unp}}^{\mathcal{I}} \sin \phi}{c_{0,\text{unp}}^{\text{BH}} + (c_{1,\text{unp}}^{\text{BH}} + c_{1,\text{unp}}^{\mathcal{I}} + \dots) \cos \phi \dots} \quad \text{higher-twist terms...}$$

The leading coefficient is related to the imaginary part of the Compton Form Factors:

$$s_{1,\text{unp}}^{\mathcal{I}} \propto \Im[F_1 \mathcal{H} + \xi(F_1 + F_2) \tilde{\mathcal{H}} - \frac{t}{4M^2} F_2 \mathcal{E}]$$

$F_1, F_2$ : Dirac,  
Pauli form factors

At CLAS kinematics, this dominates

Likewise, for the target-spin asymmetry (TSA):

$$A_{\text{UL}}(\phi) \sim \frac{s_{1,\text{LP}}^{\mathcal{I}} \sin \phi}{c_{0,\text{unp}}^{\text{BH}} + (c_{1,\text{unp}}^{\text{BH}} + c_{1,\text{unp}}^{\mathcal{I}} + \dots) \cos \phi + \dots}$$

$$s_{1,\text{LP}} \propto \Im[F_1 \tilde{\mathcal{H}} + \xi(F_1 + F_2) (\mathcal{H} + \frac{x_B}{2} \mathcal{E}) - \xi(\frac{x_B}{2} F_1 + \frac{t}{4M^2} F_2) \tilde{\mathcal{E}}]$$

\* Obtain coefficients from fitting the phi-dependence of the asymmetry:

$$A_i = \frac{\alpha_i \sin \phi}{1 + \beta_i \cos \phi}$$

At CLAS kinematics, these CFFs dominate

# Proton DVCS @ 11 GeV



Impact of CLAS12 unpolarised target proton-DVCS data on the extraction of  $\text{Re}(H)$  and  $\text{Im}(H)$ .

**$\text{Re}(H)$**

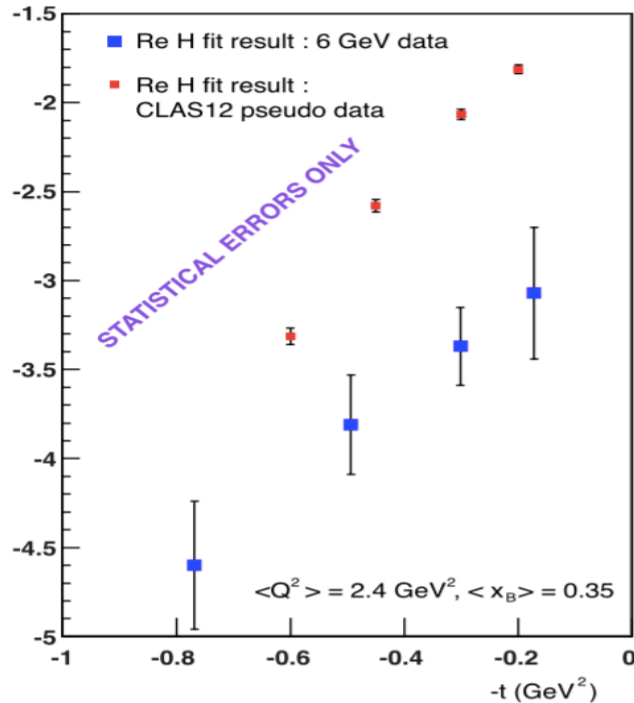

**$\text{Im}(H)$**

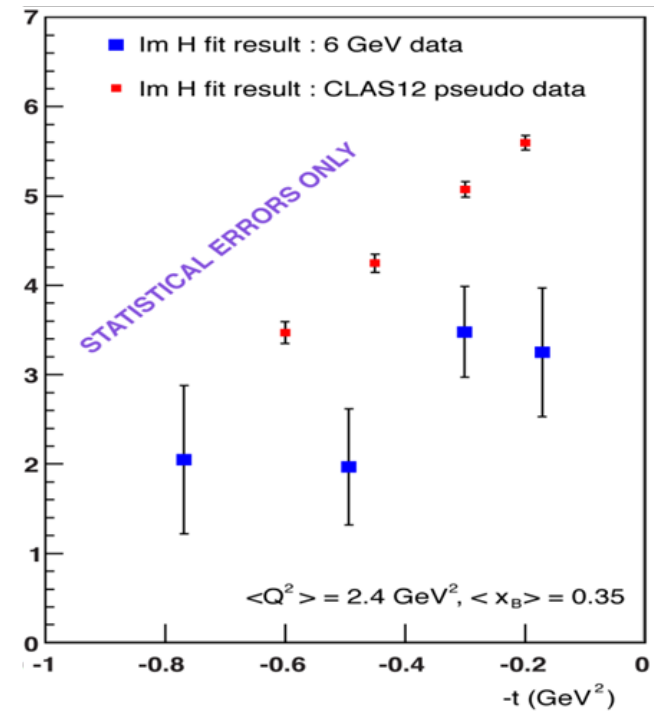

*(CLAS 6 GeV extraction H. Moutarde)*

# DVCS @ JLab12

- \* Scheduled experiments to measure cross-sections and spin asymmetries with unpolarised and longitudinally polarised liquid  $H_2$  and  $D_2$  targets using CLAS12.  $\longrightarrow$   $Im(E_n), Im(H_p), Im(\tilde{H}_p), Re(H_p)$

- Dynamic Nuclear Polarisation (DNP) of target material, cooled in a  $He$  evaporation cryostat.
- $P_{\text{proton}} = 80\%$ ,
- $P_{\text{deuteron}}$  up to 50%

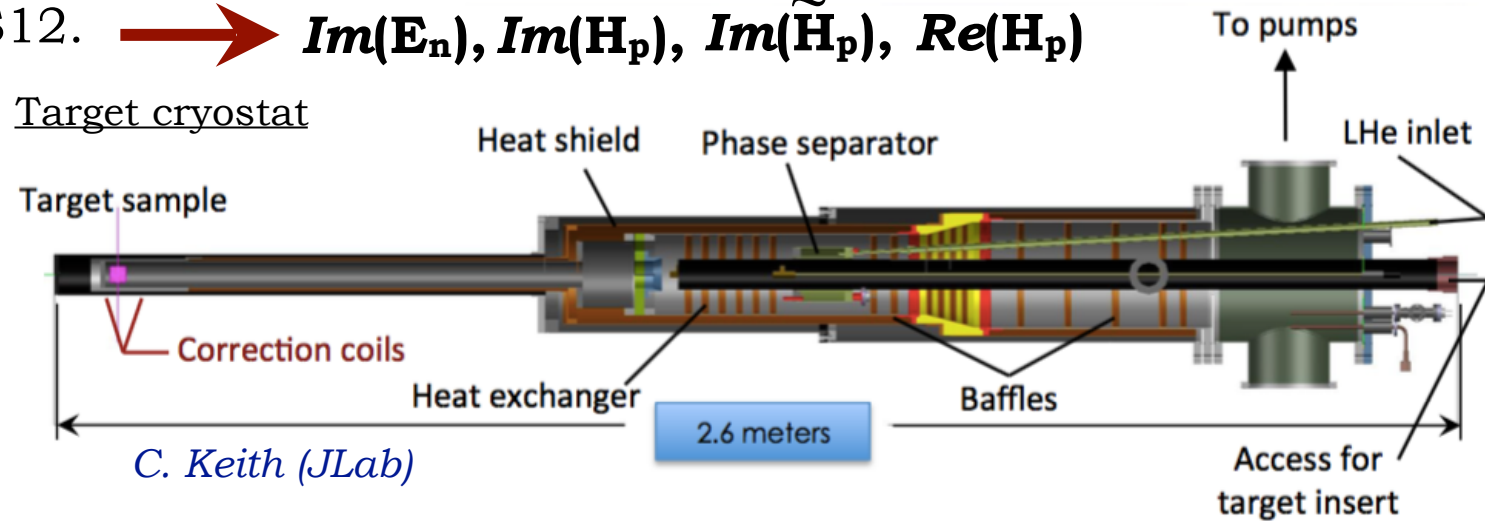

- \* Measurements of cross-sections at 10.6, 8.8 and 6.6 GeV (allows separation of pure DVCS amplitude and the DVCS/Bethe-Heitler interference terms) in Halls A, B and C.

- \* Transversely-polarised target (HD) for use with electron beams is under development (Hall B).  $\longrightarrow$   $Im(E_p)$

- \* Measurement of beam-spin asymmetry in coherent DVCS from a  $^4He$  target (CLAS12 + recoil detector ALERT): partonic structure of nuclei.  $\longrightarrow$   $Im(H_A)$

# JLab 6 GeV era DVCS X-sections: kinematics

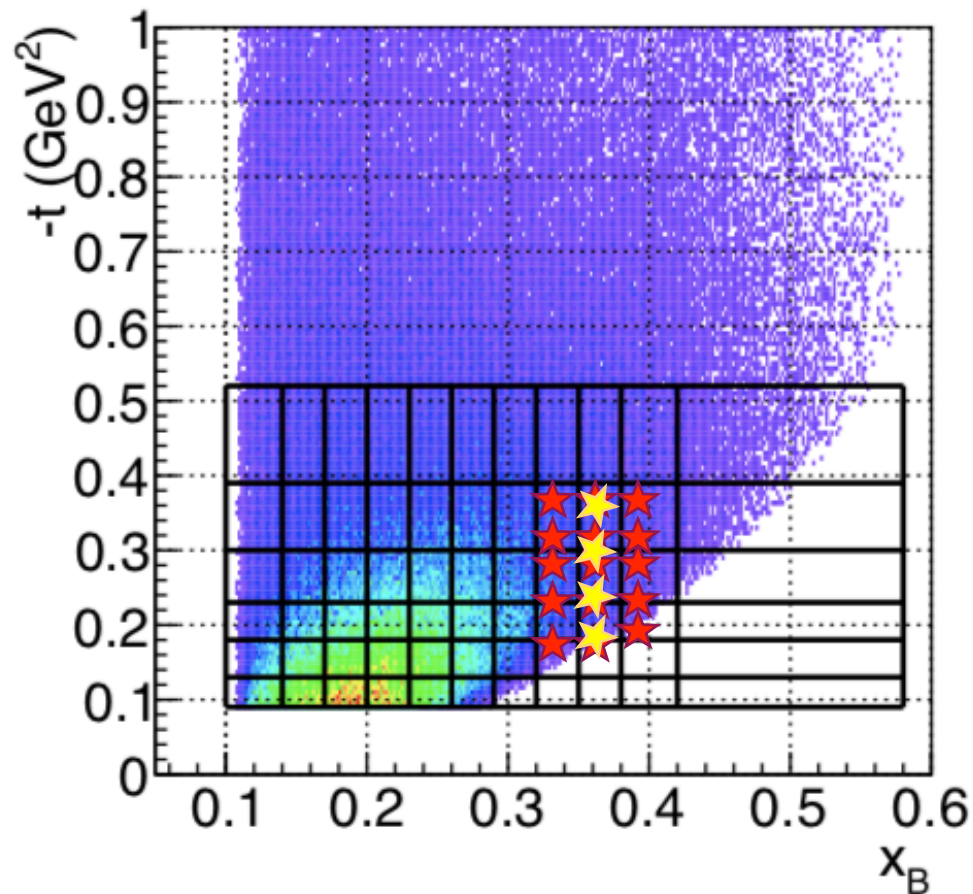
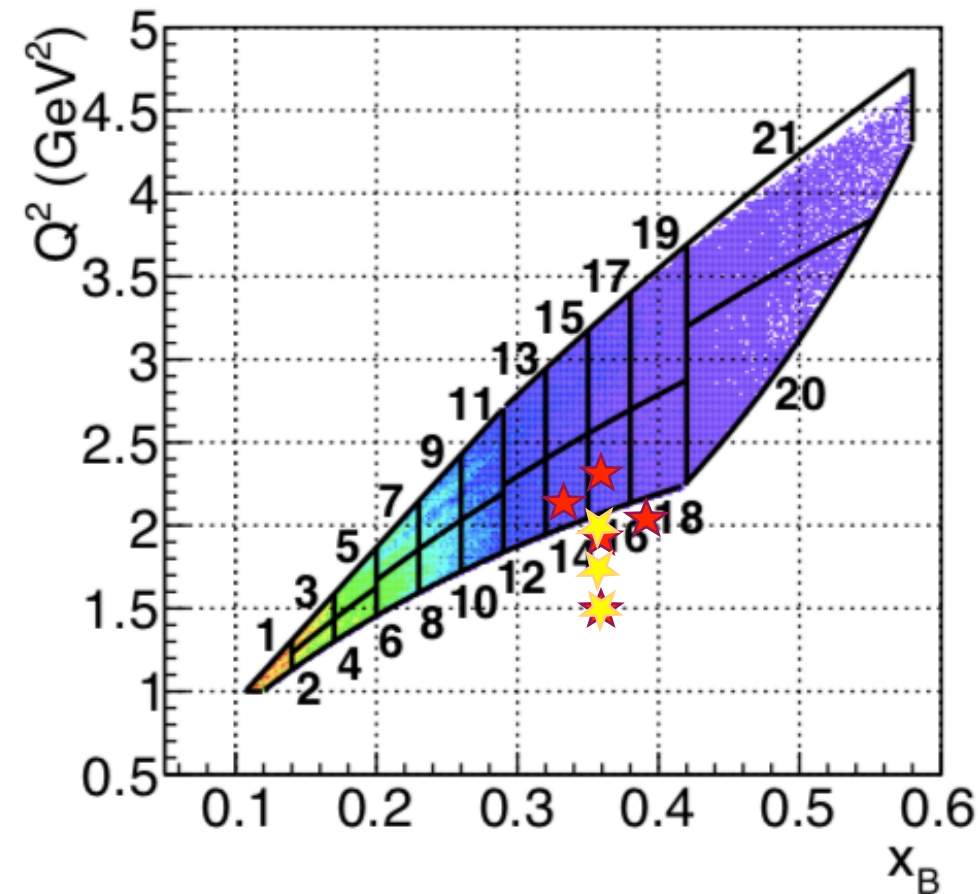

CLAS 2D distributions: H.-S. Jo *et al* (CLAS), **PRL 115** (2015) 212003

★ M. Defurne *et al*, **PRC 92** (2015) 055202

Hall A

★ M. Defurne *et al*, **Nature Communications 8** (2017) 1408

# Proton DVCS @ 11 GeV



Experiment E12-06-119

*F. Sabatié et al.*

$$P_{\text{beam}} = 85\%$$

$$L = 10^{35} \text{ cm}^{-2}\text{s}^{-1}$$

$$1 < Q^2 < 10 \text{ GeV}^2$$

$$0.1 < x_B < 0.65$$

$$-t_{\text{min}} < -t < 2.5 \text{ GeV}^2$$

*Kinematics similar for all proton DVCS  
@ 11 GeV with CLAS12 experiments*

## Unpolarised liquid H<sub>2</sub> target:

- Statistical error: 1% - 10% on  $\sin\varphi$  moments
- Systematic uncertainties: ~ 6 - 8%

$A_{\text{LU}}$  characterised by imaginary parts of

CFFs via:  $F_1 H + \xi G_M \tilde{H} - \frac{t}{4M^2} E \longrightarrow \text{Im}(H_p)$

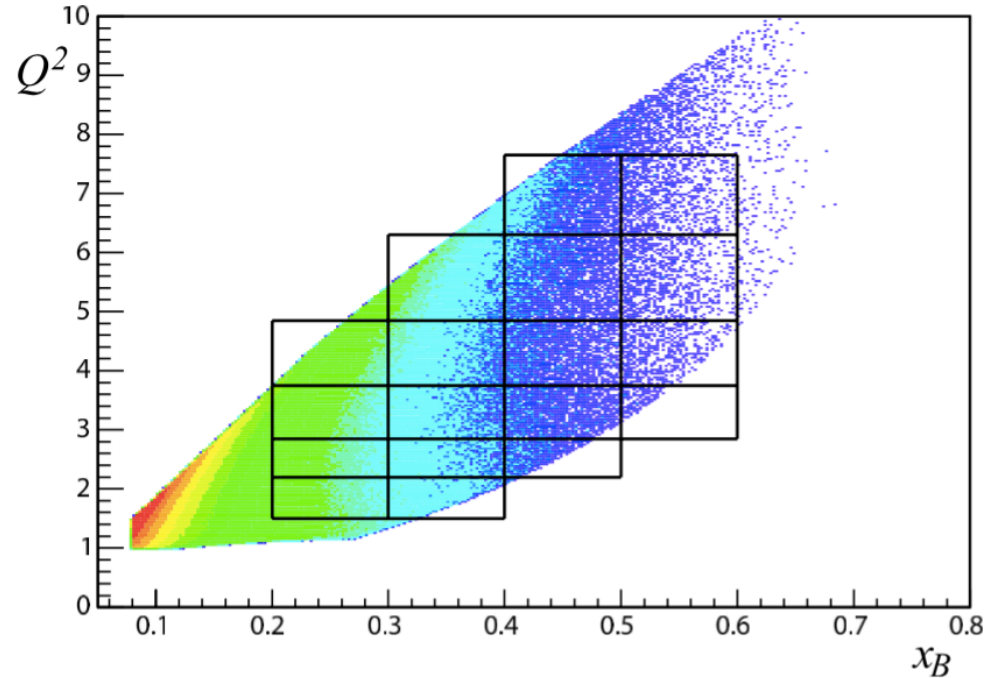

**First experiment with CLAS12**

*Started this February!*

# DVCS at lower energies with CLAS12



Experiment E12-16-010B

*F.-X. Girod et al.*

## Unpolarised liquid H<sub>2</sub> target:

- Beam energies: 6.6, 8.8 GeV
- Simultaneous fit to beam-spin and total cross-sections.
- \* Rosenbluth separation of interference and  $|T_{DVCS}|^2$  terms in the cross-section
- \* Scaling tests of the extracted CFFs
- \* Model-dependent determination of the D-term in the Dispersion Relation between *Re* and *Im* parts of CFFs: sensitivity to Gravitational Form Factors.

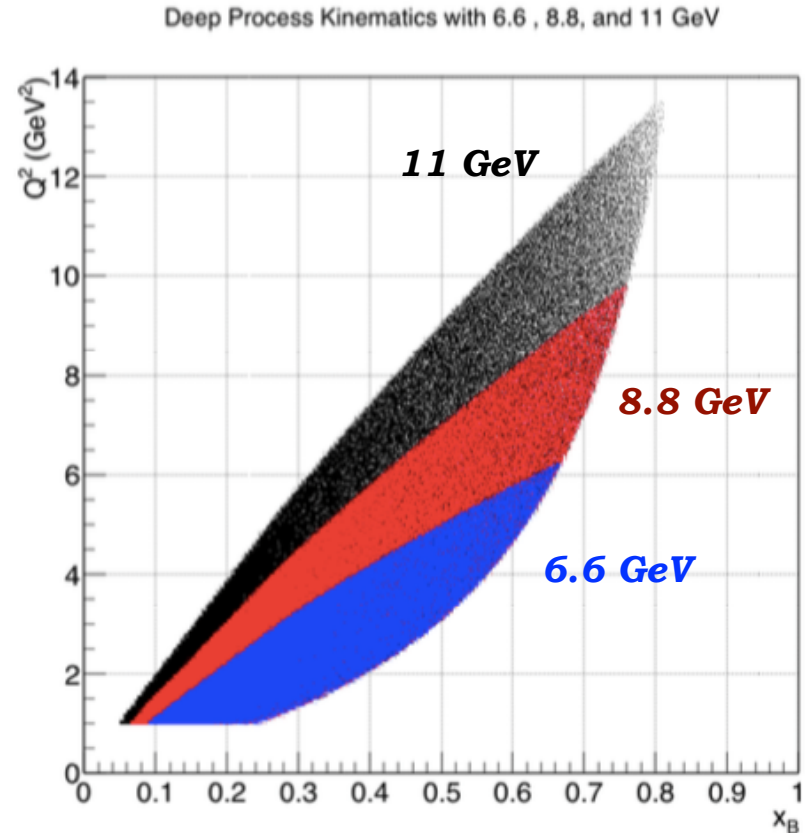

Compare with measurements from Halls A and C: cross-check model and systematic uncertainties.



# DVCS at lower energies with CLAS12

Projected extraction of CFFs (red) compared to generated values (green). Three curves on the  $Re(H)$  show three different scenarios for the D-term.

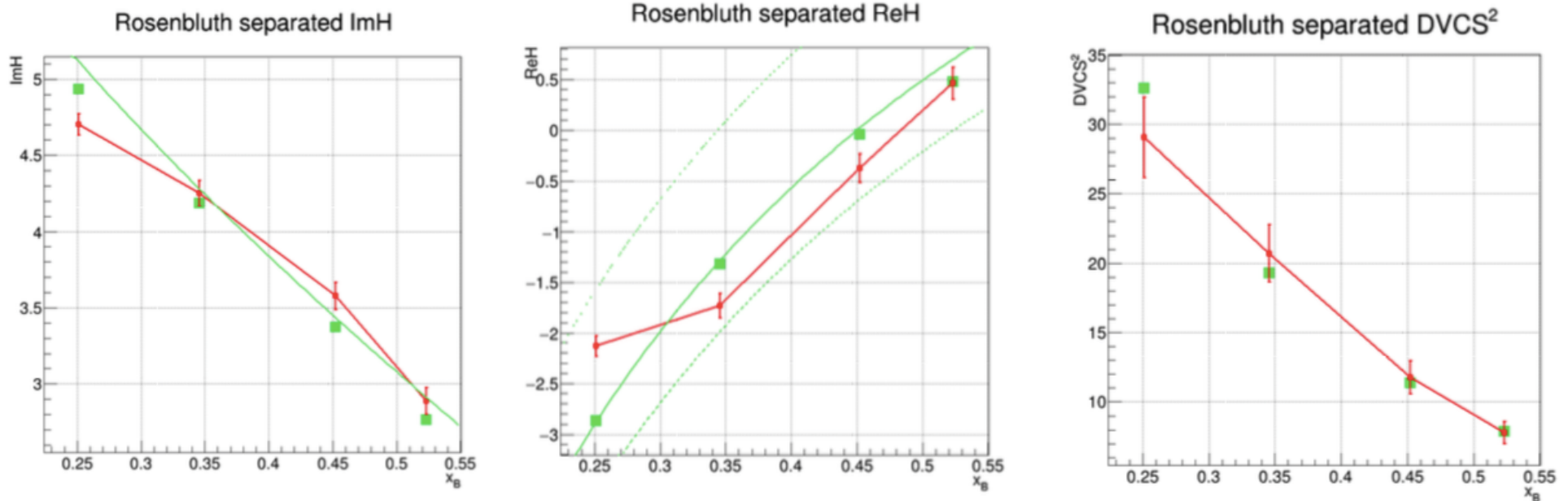

*F.-X. Girod et al.*

CLAS12

# Neutron DVCS @ 11 GeV

Experiment E12-11-003

*S. Niccolai, D. Sokhan et al.*

$$\Delta\sigma_{\text{LU}} \sim \sin\phi \operatorname{Im} \{ F_1 H + \xi(F_1 + F_2) \tilde{H} - k F_2 E \} d\phi$$

0  $-t$  1.2 Simulated statistical sample:

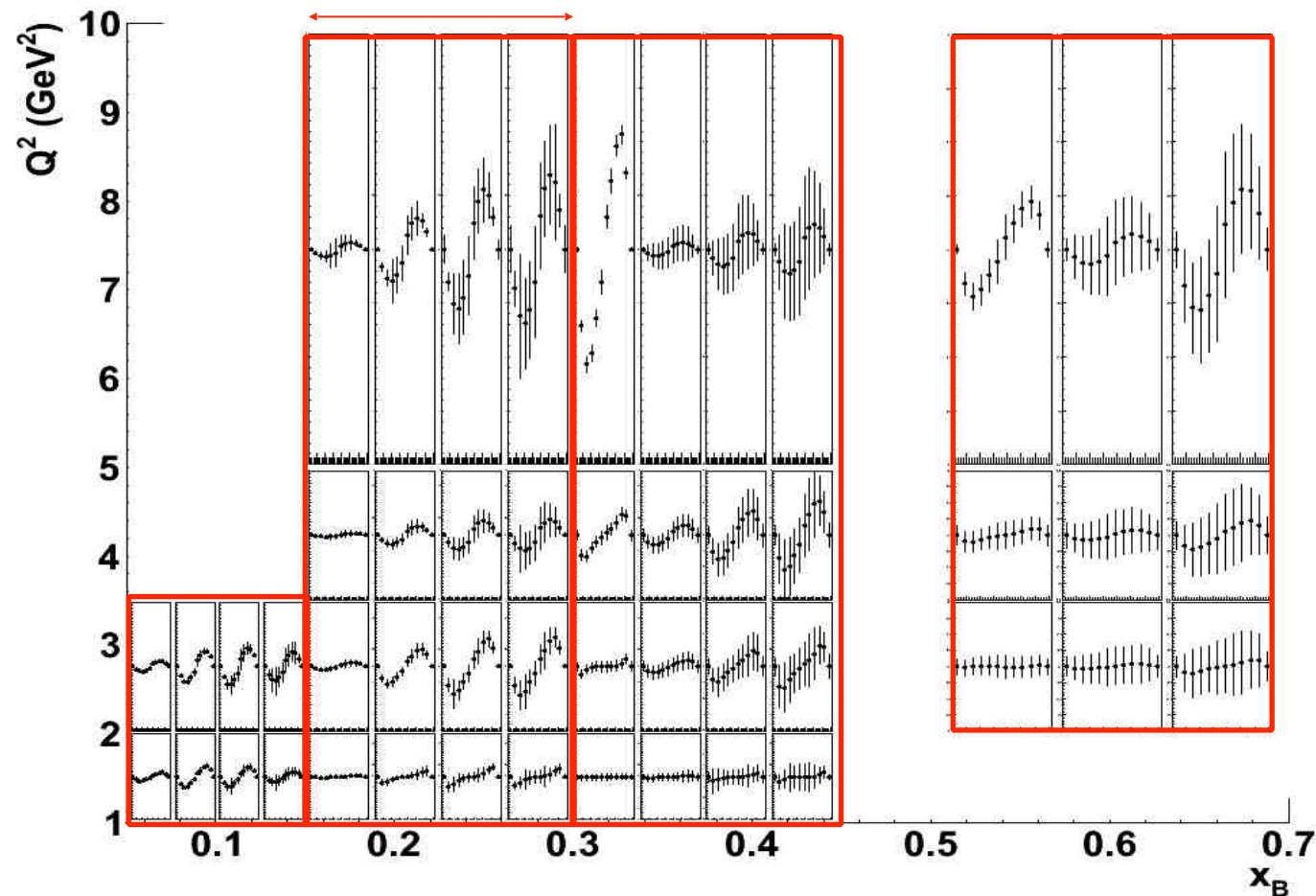

$\operatorname{Im}(E_n)$  dominates.

$$L = 10^{35} \text{ cm}^{-2}\text{s}^{-1}/\text{nucleon}$$

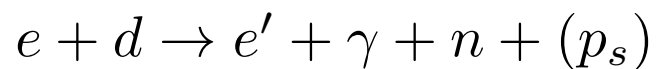

CLAS12 +  
Forward Tagger +  
**Neutron Detector**

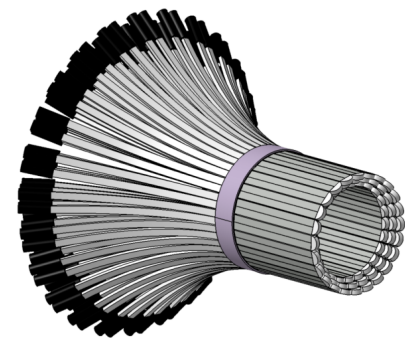

Scheduled: 2019

CLAS12

# Neutron DVCS with a longitudinally polarised target

Experiment E12-06-109A.  
*S. Niccolai, D. Sokhan et al.*

## Longitudinally polarised ND<sub>3</sub> target:

- Dynamic Nuclear Polarisation (DNP) of target material in a cryostat shared with the NH<sub>3</sub> target.
- P<sub>deuteron</sub> up to 50%
- Systematic uncertainties: ~ 12%

AUL characterised by imaginary parts of CFFs via:

$$F_1 \tilde{H} + \xi G_M \left( H + \frac{x_B}{2} E \right) - \frac{\xi t}{4M^2} F_2 \tilde{E} + \dots$$

→ ***Im(H<sub>n</sub>)***

In combination with pDVCS, will allow flavour-separation of the  $H_q$  CFFs.

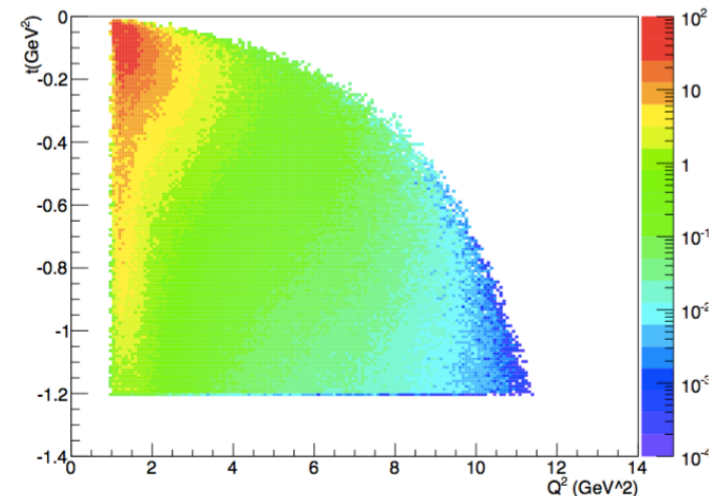
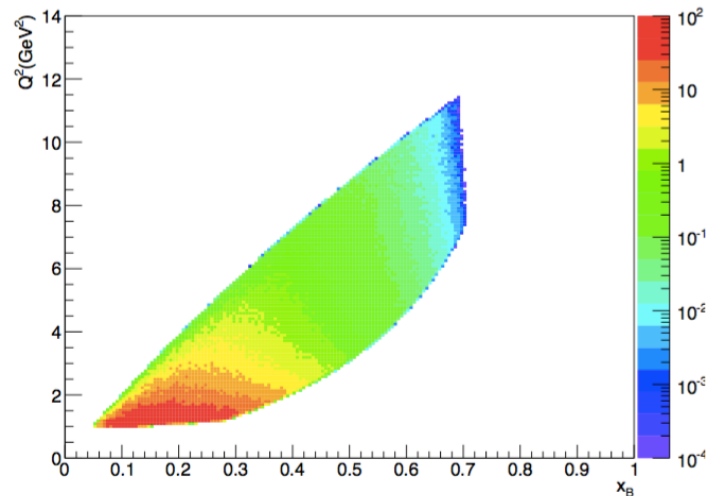

Tentative schedule: 2020



# Proton DVCS with transversely polarised target at CLAS12

C12-12-010: with transversely polarised HD target (conditionally approved).

*L. Elouardhiri et al.*

$\Delta\sigma_{UT} \sim \cos\phi \text{Im}\{k(F_2H - F_1E) + \dots\}d\phi$       Sensitivity to ***Im(E)*** for the proton.

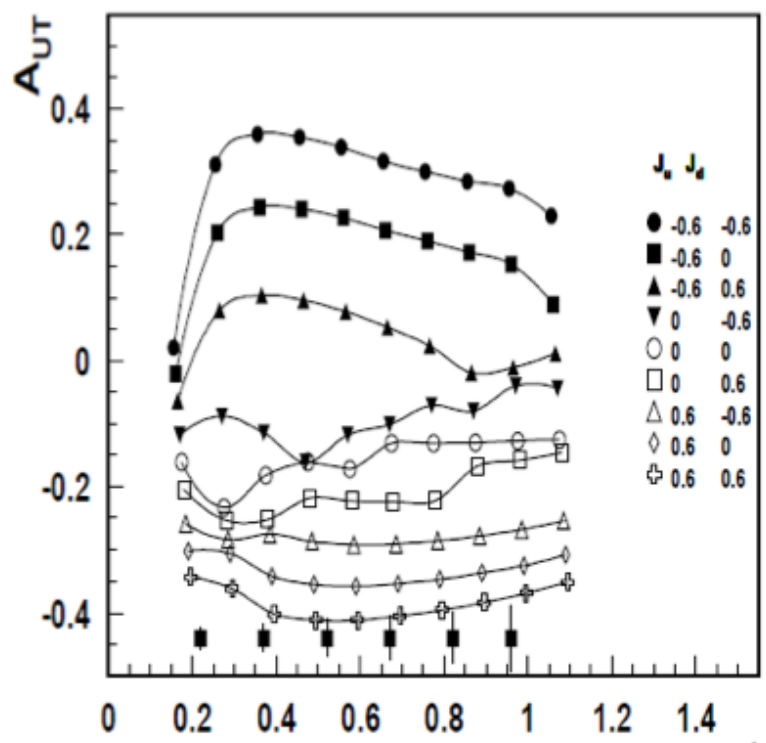
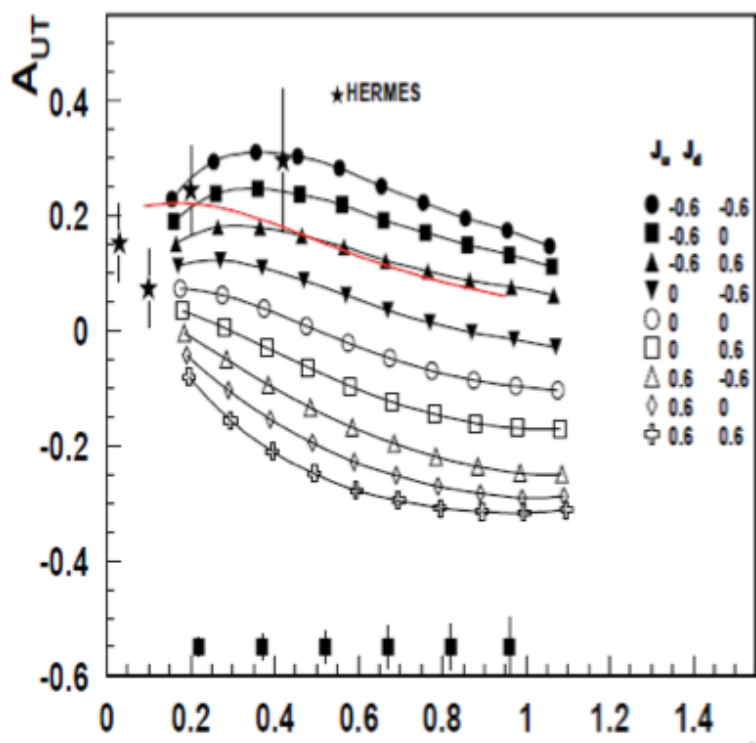

*VGG extraction*  
*(M. Guidal)*

$\langle x \rangle = 0.2, \langle Q^2 \rangle = 2.5 \text{ GeV}^2$

$\langle x \rangle = 0.33, \langle Q^2 \rangle = 2.5 \text{ GeV}^2$

# Towards nucleon tomography: local fits

Quasi model-independent extraction of CFFs based on a local fit:

- \* Set 8 CFFs as free parameters to fit, at each  $(x_B, t)$  point, the available observables.
- \* Limits imposed within +/- 5 times the VGG model predictions (Vanderhaeghen-Guichon-Guidal).
- \* Leading-twist DVCS amplitude parametrisation based on Double Distributions.

The best constraints in fits to CLAS data were obtained on  $H_{Im}$ .

Parametrise its dependence on  $t$ :

$$H_{Im}(\xi, t) = A(\xi)e^{B(\xi)t}$$

*Relates to quark density*

*Inverse relation to spatial distribution*

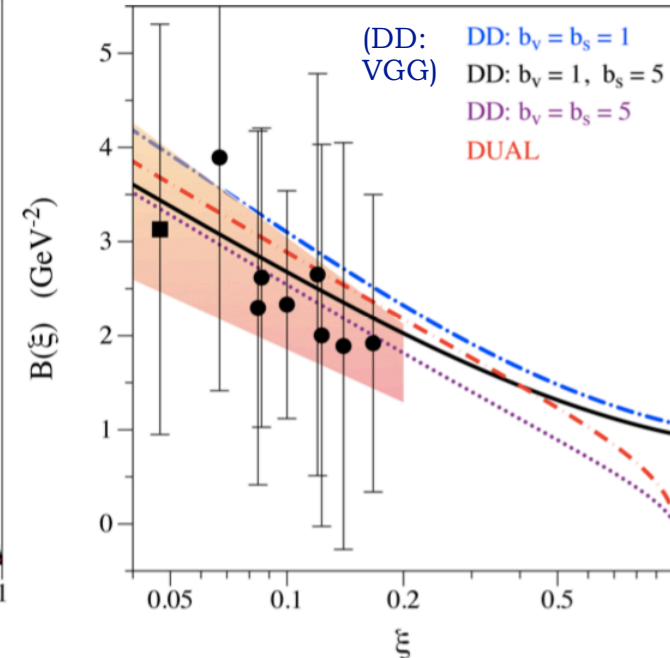
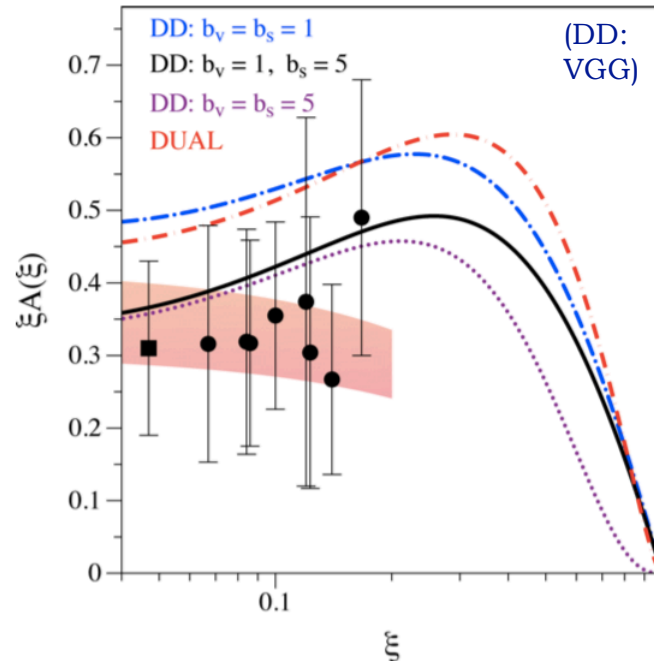

# Towards nucleon tomography: local fits

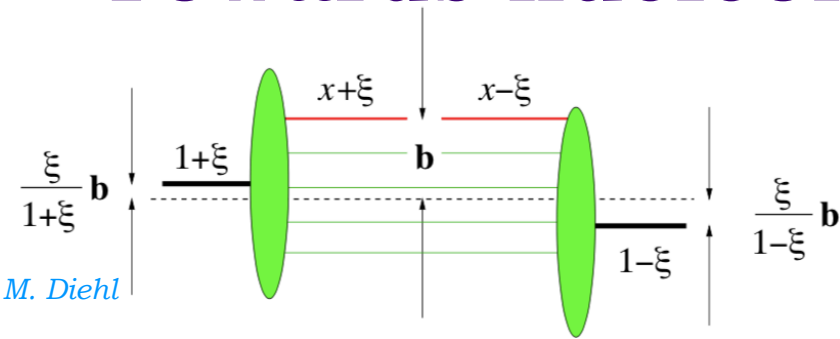

*Transverse parton position interpretation only at  $\xi = 0$ .*

Assuming leading-twist and exponential dependence of GPD on  $t$ , using models to extrapolate to the zero skewness point  $\xi = 0$  and assuming similar behaviour for  $u$  and  $d$  quarks there:

$$\langle b_{\perp}^2 \rangle^q(x) = -4 \frac{\partial}{\partial \Delta_{\perp}^2} \ln H_{-}^q(x, 0, -\Delta_{\perp}^2) \Big|_{\Delta_{\perp}^2=0}$$

Relating the impact parameter to helicity-averaged transverse distribution:

$$t = \Delta_{\perp}^2$$

$$\rho^q(x, \mathbf{b}_{\perp}) = \int \frac{d^2 \Delta_{\perp}}{(2\pi)^2} e^{-i\mathbf{b}_{\perp} \cdot \Delta_{\perp}} H_{-}^q(x, 0, -\Delta_{\perp}^2)$$

$$H_{-}^q(x, 0, t) \equiv H^q(x, 0, t) + H^q(-x, 0, t)$$

*Transverse four-momentum transfer to nucleon*

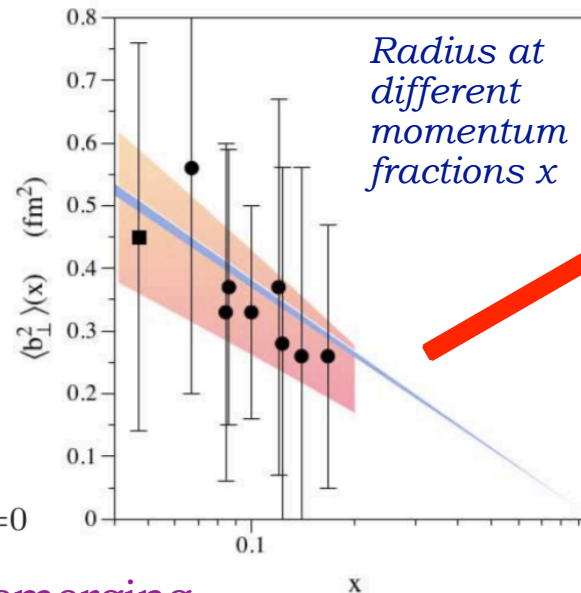

*Radius at different momentum fractions  $x$*

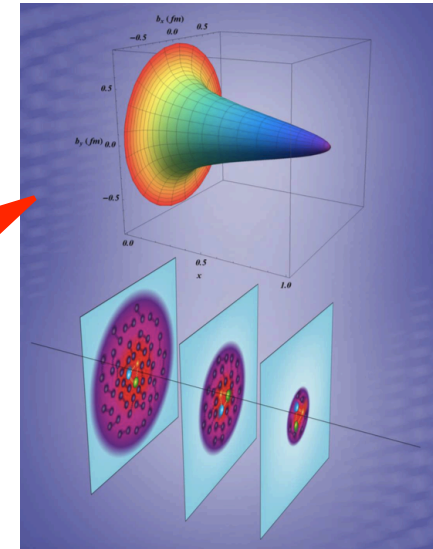

Tentative hints of 3D distributions are emerging.

*We need more data from JLab @ 11 GeV!*

# Towards nucleon tomography: global fits

- \* PARTONS framework: global fits and neural networks to minimise model-dependence in the extraction of CFFs.

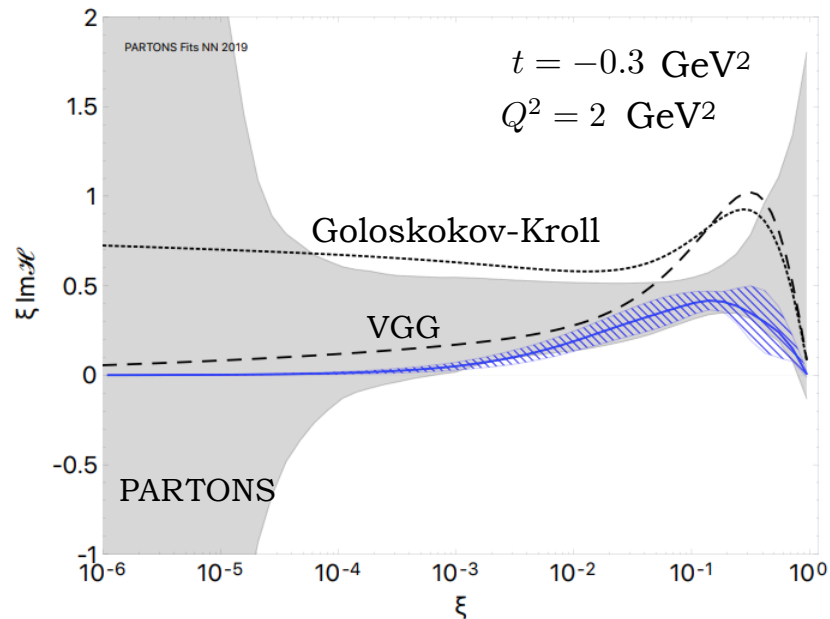

H. Moutarde *et al.*, Eur. Phys. J C79, 614 (2019)

Inclusion of other channels into PARTONS underway.

Framework in place: more data needed!

Image from Pawel Sznajder, IWHSS 2019

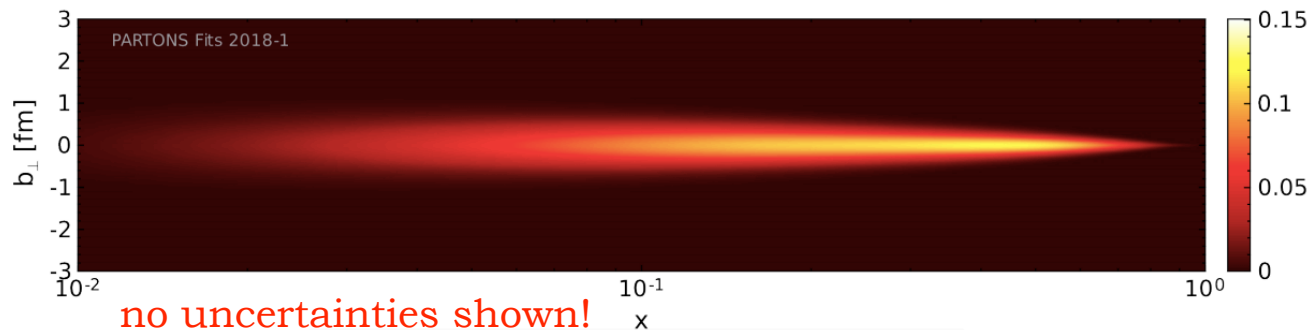
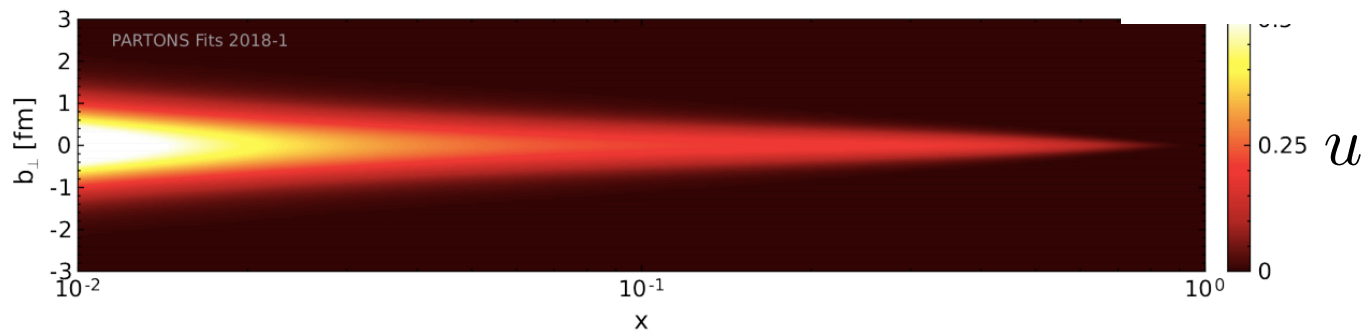

no uncertainties shown!