



# Current Status of GEM activities in THU and the building of pRad GEM

- **Current status of GEM in THU**
- **pRad GEM in UVa**
- **summary**

Yan Huang, Zhigang Xiao (THU)  
Liming duan, Junwei Zhang(IMP)  
Nilanga Liyanage, Xinzhan Bai(UVa)



Kunshan China

# Manpower and Fund (THU)

- Manpower: 1 PhD student + 1 professor
- Fund: NSFC collaborative project + Tsinghua University Initiative Scientific Research Program.

(Total Investment: about 1M CNY in GEM research)



- Non-uniformity effect of inter-foil distance on GEM performance
- Larger GEM detector performance



# Non-uniformity effect studies

- To introduce a wedge-shaped foil gap in a small GEM detector to mimic the non-uniform inter-foil distance.

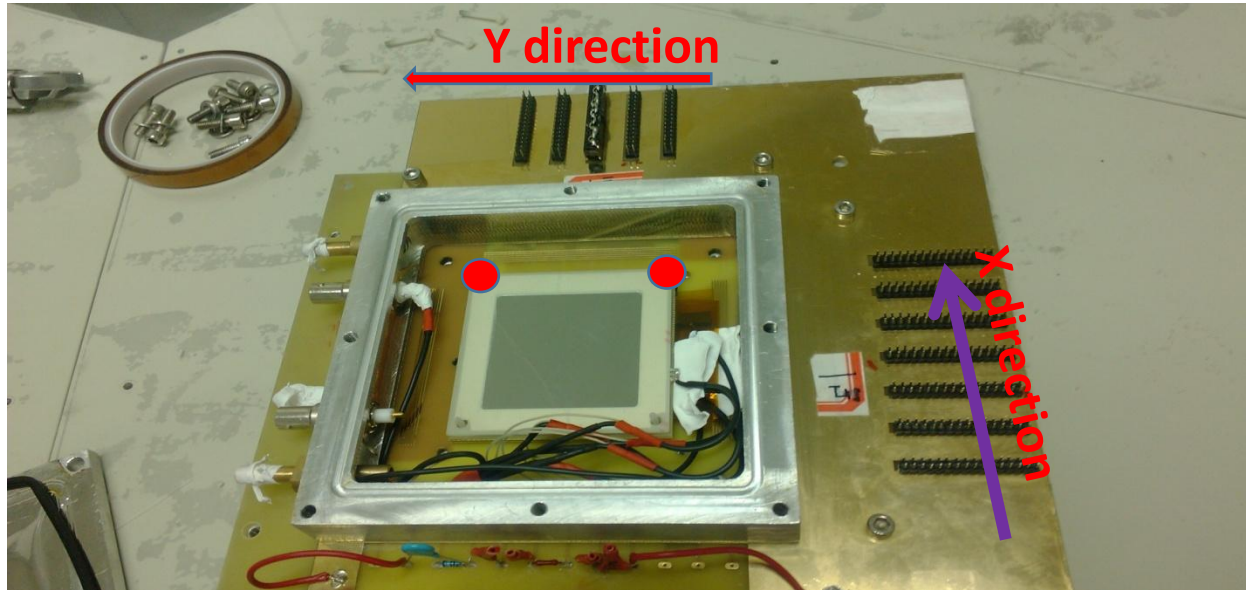

● : stands for the paddle

We have disassembled the 2D GEM and put a paddle between the two foils in one side along X.

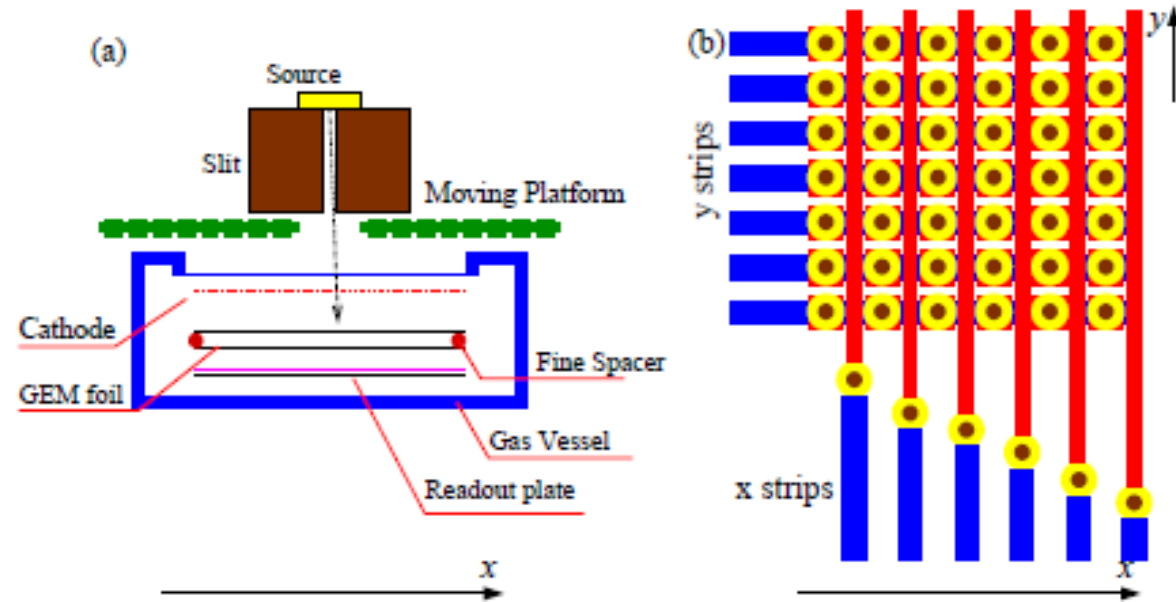

Schematic view of the experimental setup

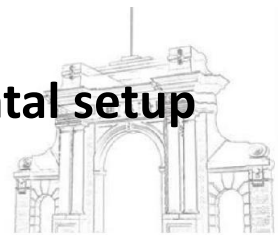

# Non-uniformity effect studies

- The gain exhibits a linear dependence on the change of foil gap thickness, the rate is the same for all gas mixture or working voltage.

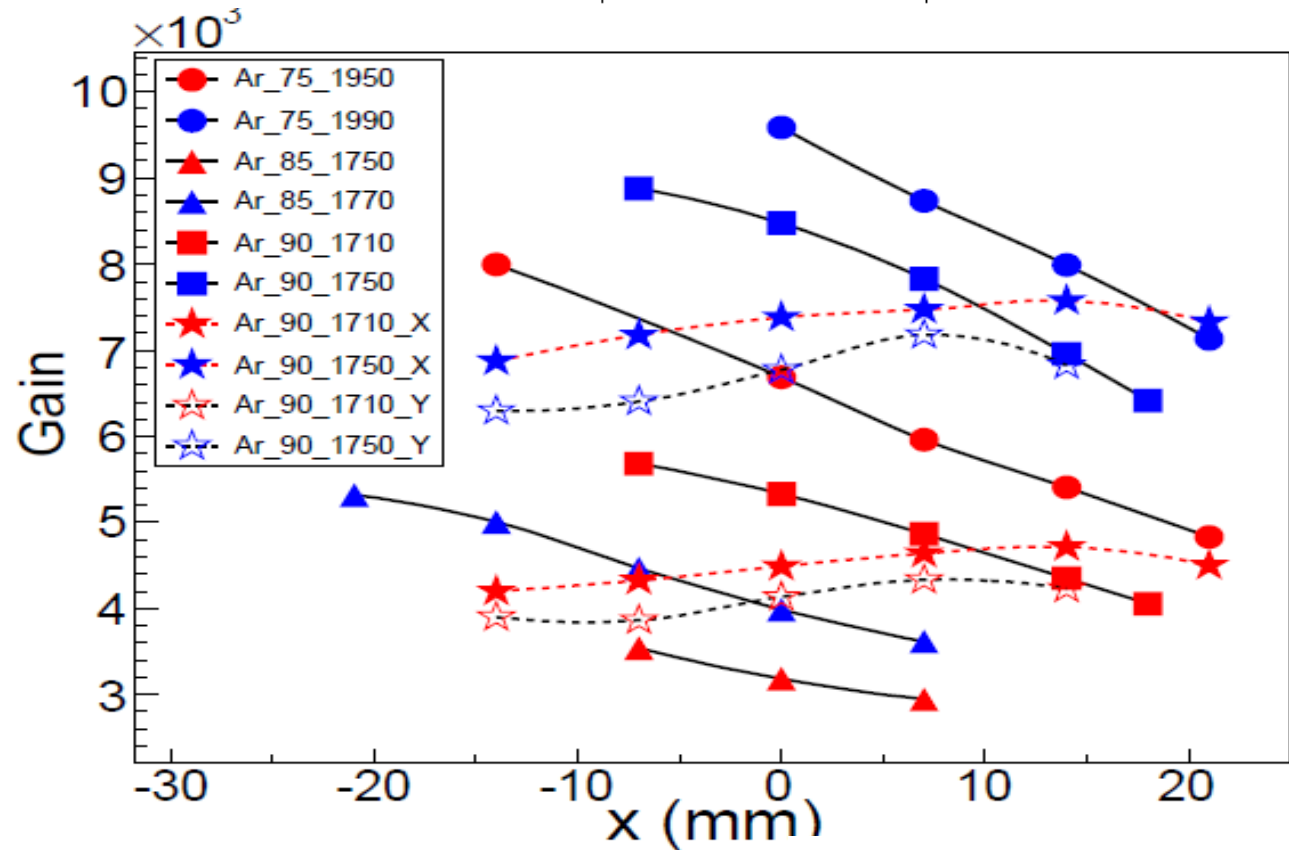
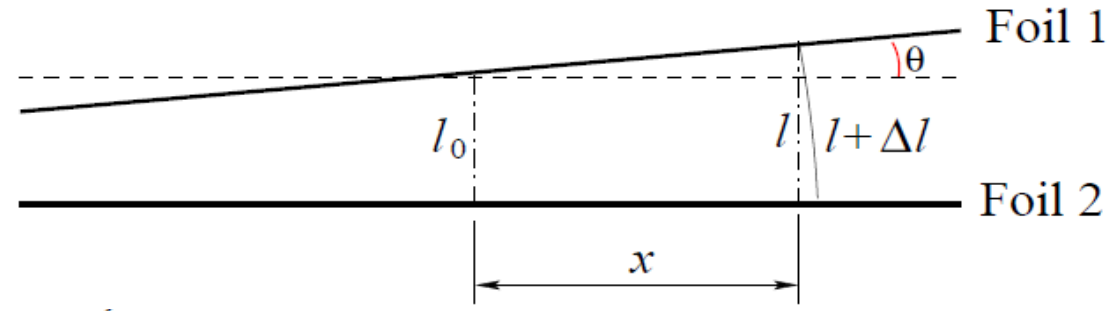

- 1% change of the foil gap thickness leads to  $(1.0 \pm 0.1)\%$  change of the gain, regardless of the tilted angle of the two foil.
- This correspondence can be used in the evaluation of the non-uniformity of large-area GEM detector if the gain distribution can be measured.

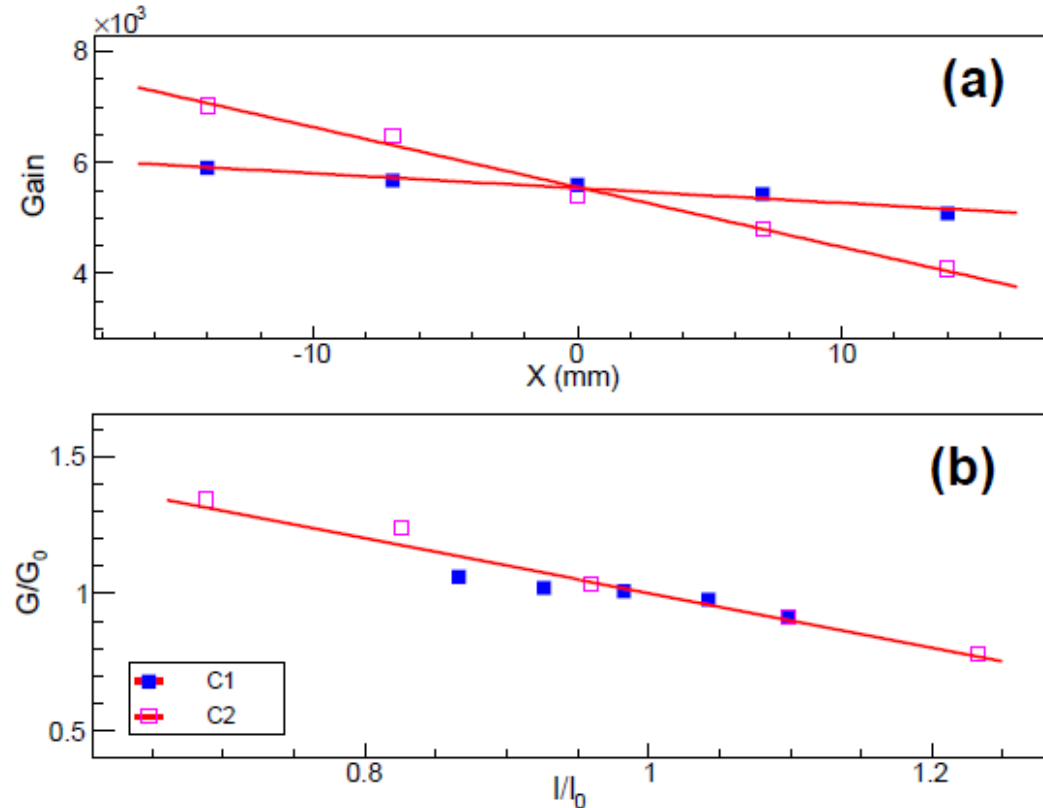

Fig. 7. (Color online) The gain, represented by the channel of the full energy peak, as a function of the incident position of the Fe-55 X ray (a) and as a function of the gap thickness (b) normalized to the thickness at the central point.

- Spatial resolution shows insignificant dependence on the foil gap thickness,
- It is sensitive to the design of the readout strip parameters.

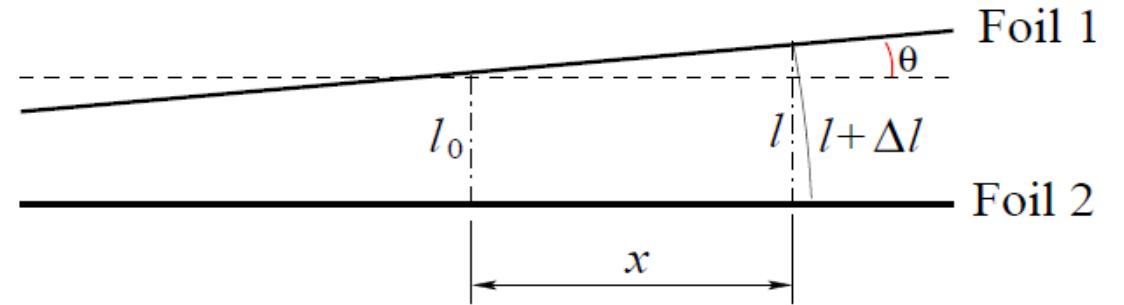
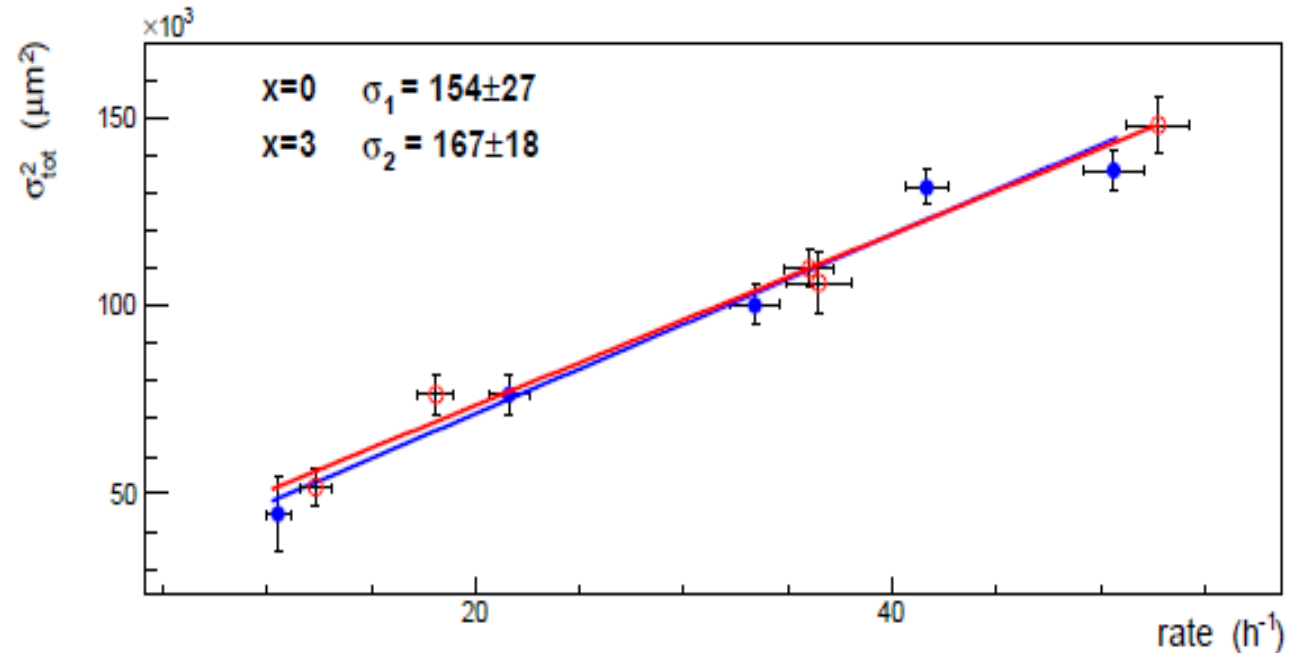

Table 2

The position resolution at different strip conditions

Strip Width ( $\mu m$ )	$\sigma_{exp}(\mu m)$	$d/\sqrt{12}(\mu m)$
$d_x(d_y) = 446(625)$	$204 \pm 13$	160
$d_x = 446$	$159 \pm 22$	129
$d_x = 200$	$56 \pm 15$ [21]	58



# Large-area GEM detector studies

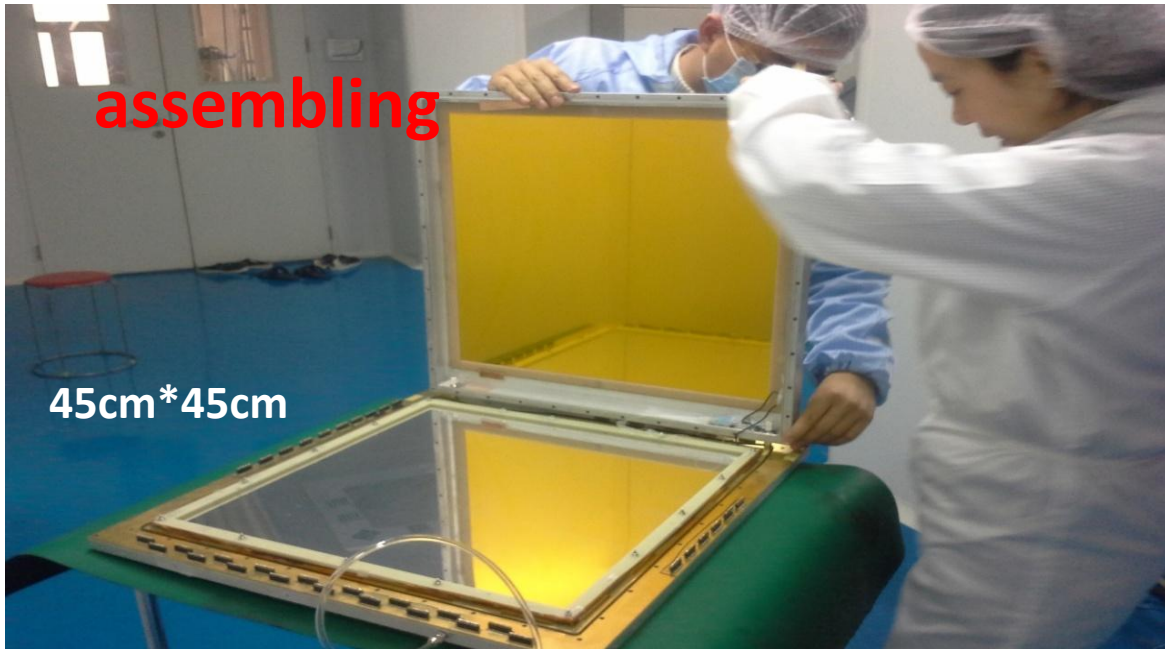
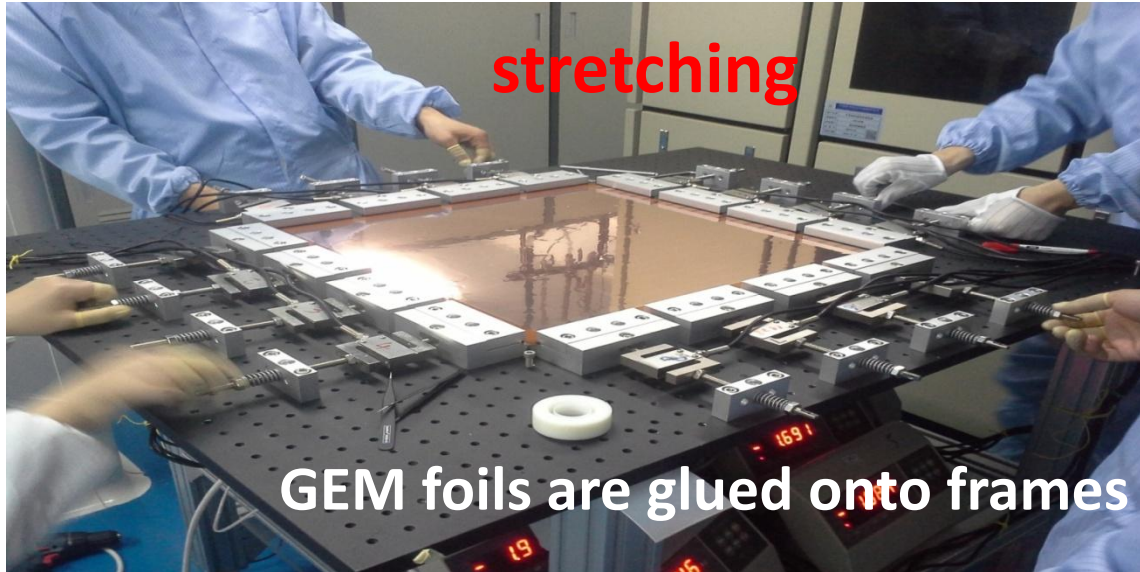

Collaborate with Prof. Limin Duan's group (Herun Yang, Junwei Zhang) at IMP.

- Tested the GEM chamber over a fraction of the active area when only two GEM layers were assembled.

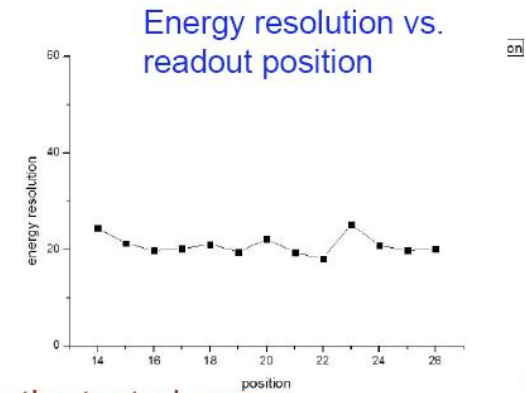
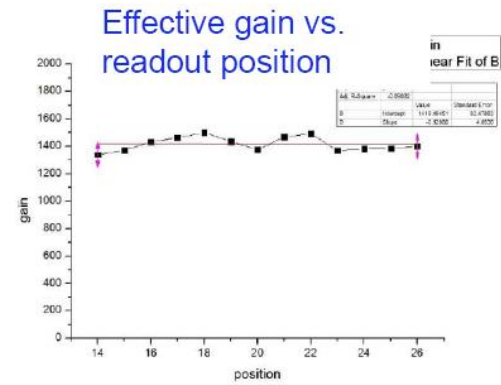

Good uniformity over the tested area

Tsinghua & IMP

- However, sparks occurred in one sector when all 3 GEM layers were assembled.
  - Drawback of the fabrication method: non-uniform GEM foil stretching.

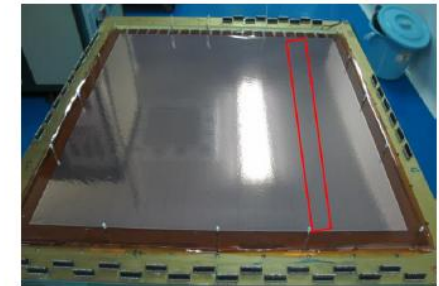



# Large-area GEM detector studies

- Main improvement is made in the stretch of the large GEM foil, no glue utilized, self-stretched; similar to the NS2 technique developed at CERN.

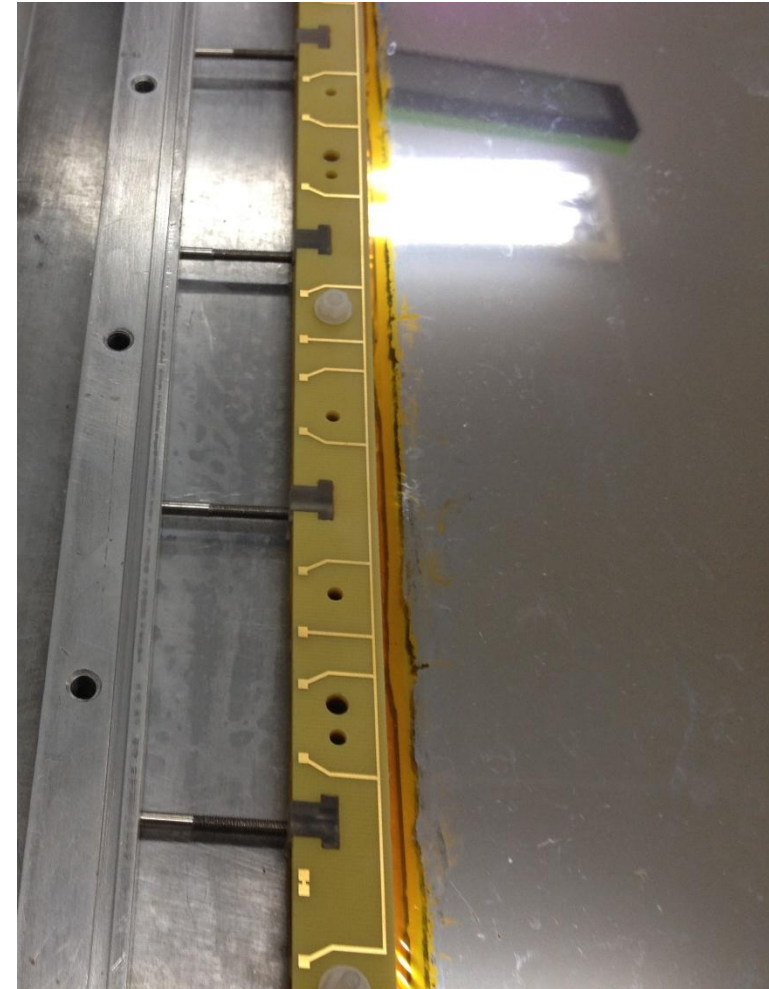
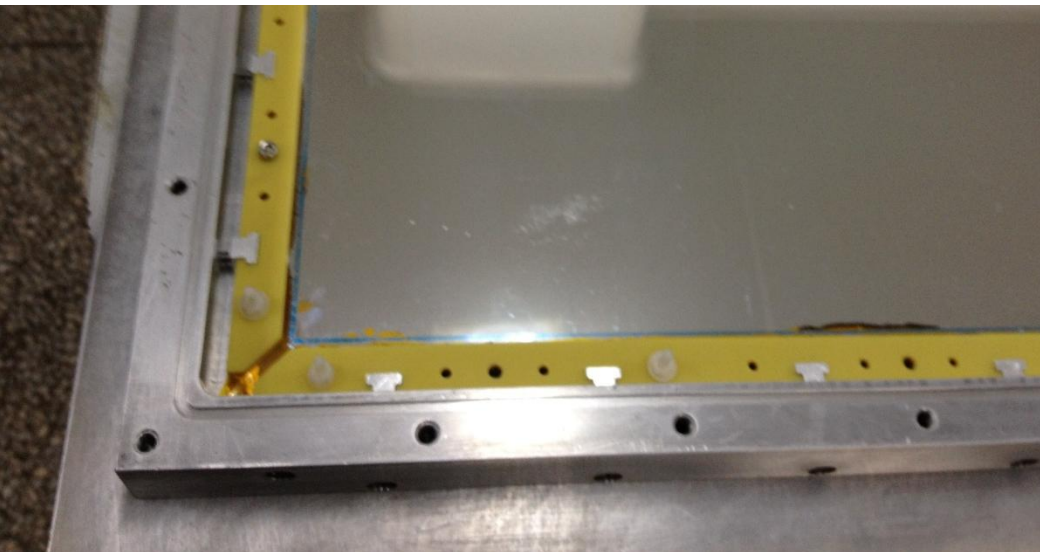

# Double-Foil detector has been mounted

- Currently 2 Layers, go three layers further

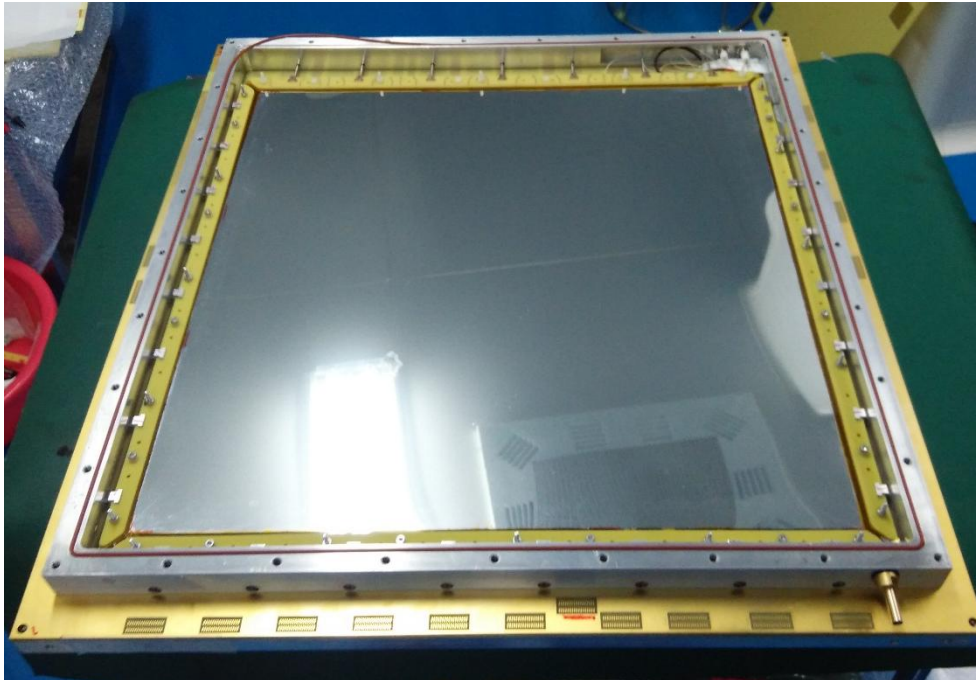
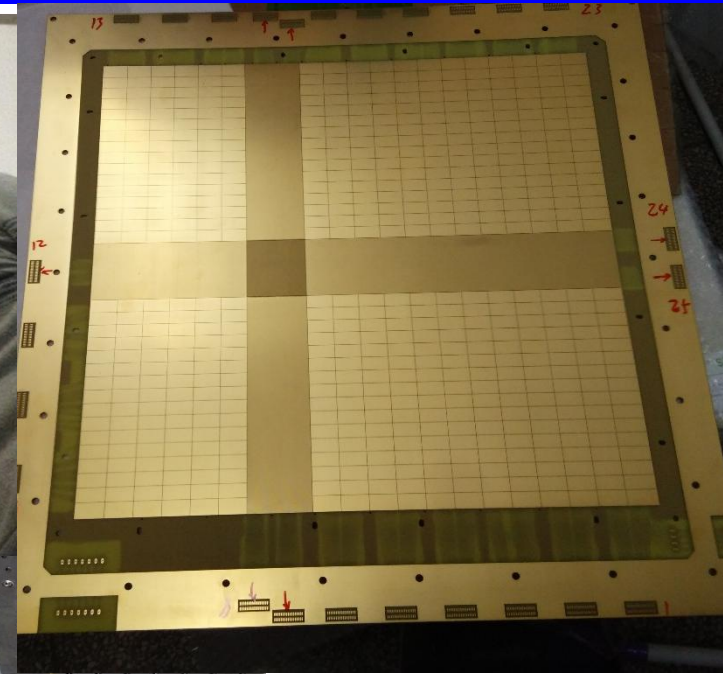

- Gas: Ar80% + CO<sub>2</sub> 20%
- Working Voltage: -1650 V
- Resolution =  $72/635 * 2.36 = 26.7\%$
- Preliminary test: One readout for 32 strips or pads
- Stripe distance: 400 (X)/600(Y)  $\mu\text{m}$
- Pad Size: 22.3mm\*12.3mm

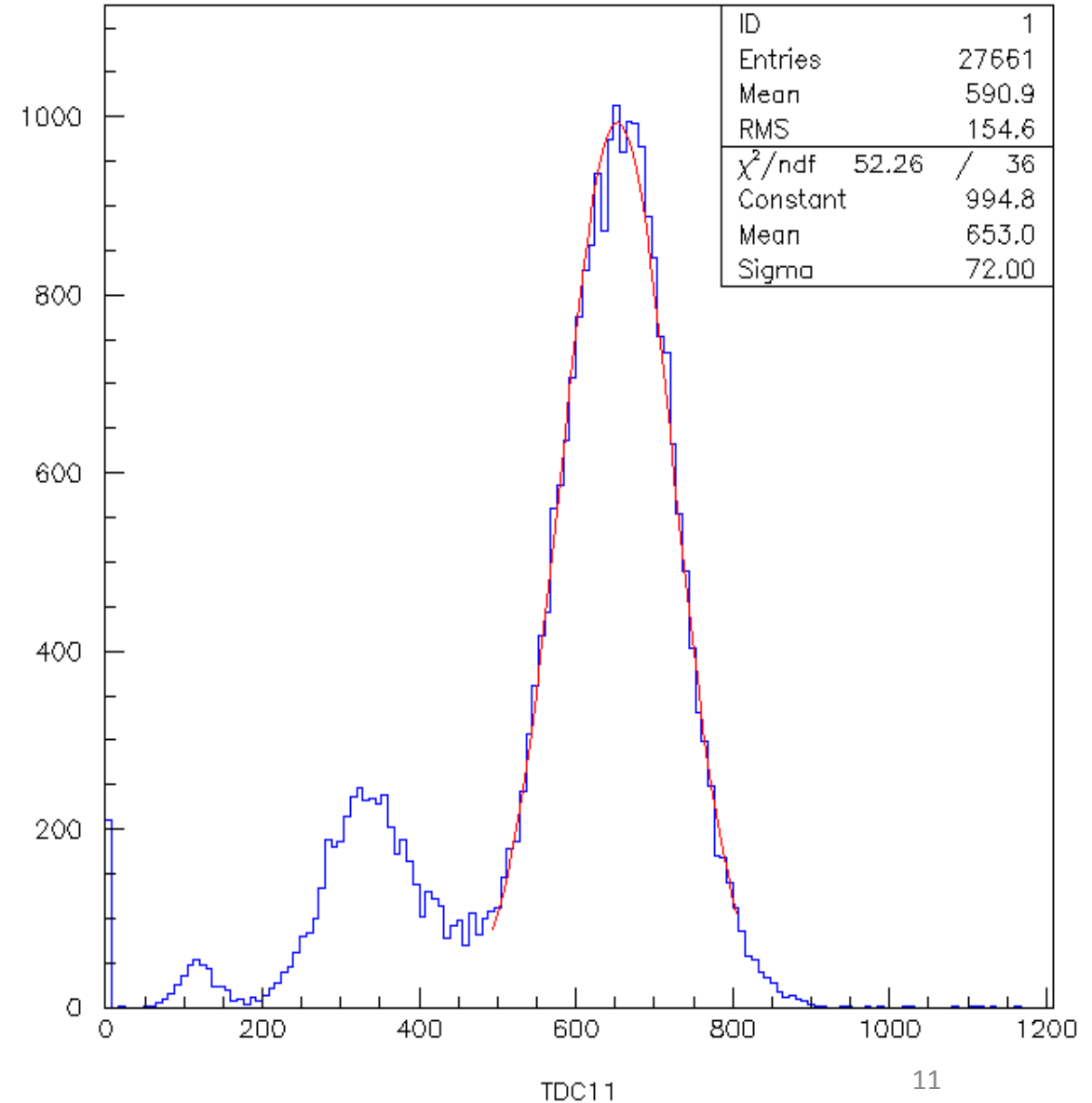

# Uniformity Test

- Large non-uniformity, **Strips** see larger noise, while noise on pads are smaller.
- Detailed test required

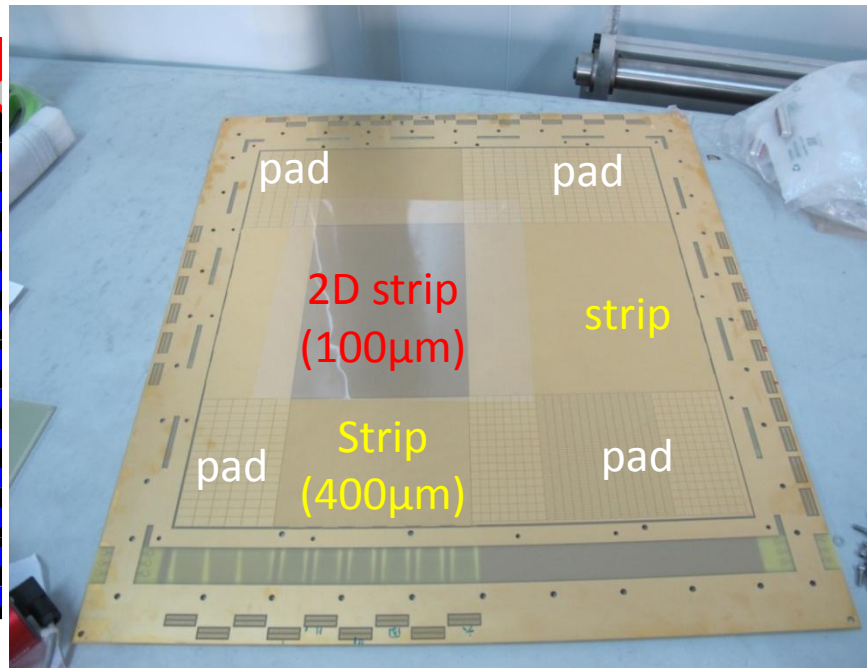
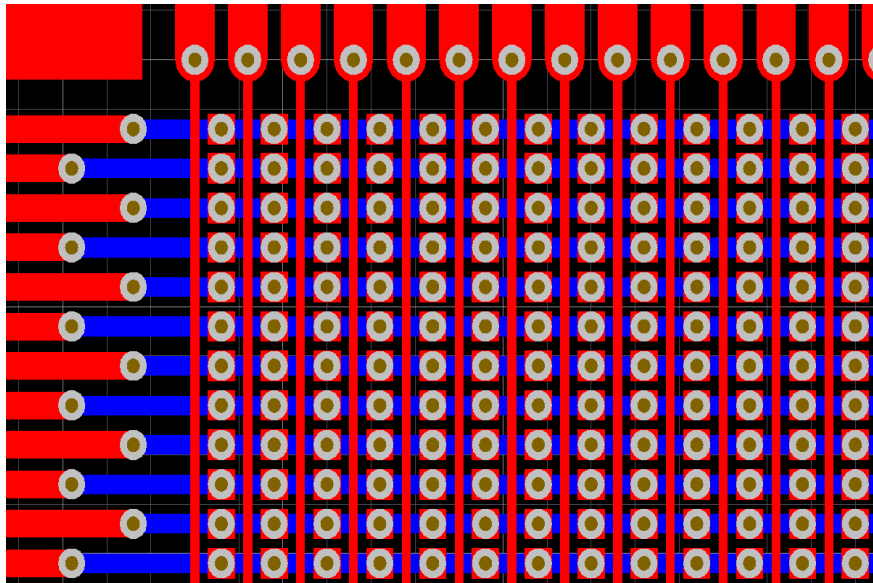

Strip #	Peak	Sigma
3	653	72
5	560	81
<b>7</b>	<b>549</b>	<b>74</b>
10	588	61
<b>12</b>	<b>570</b>	<b>107</b>
13	653	75
<b>16</b>	<b>579</b>	<b>103</b>
19	542	77
22	620	75
<b>25</b>	<b>554</b>	<b>105</b>

# Systematic non-uniformity is observed

- We observed systematic non-uniformity along one direction, indicating that the stretching of the large foil is not optimized.
- Improvement is ongoing.

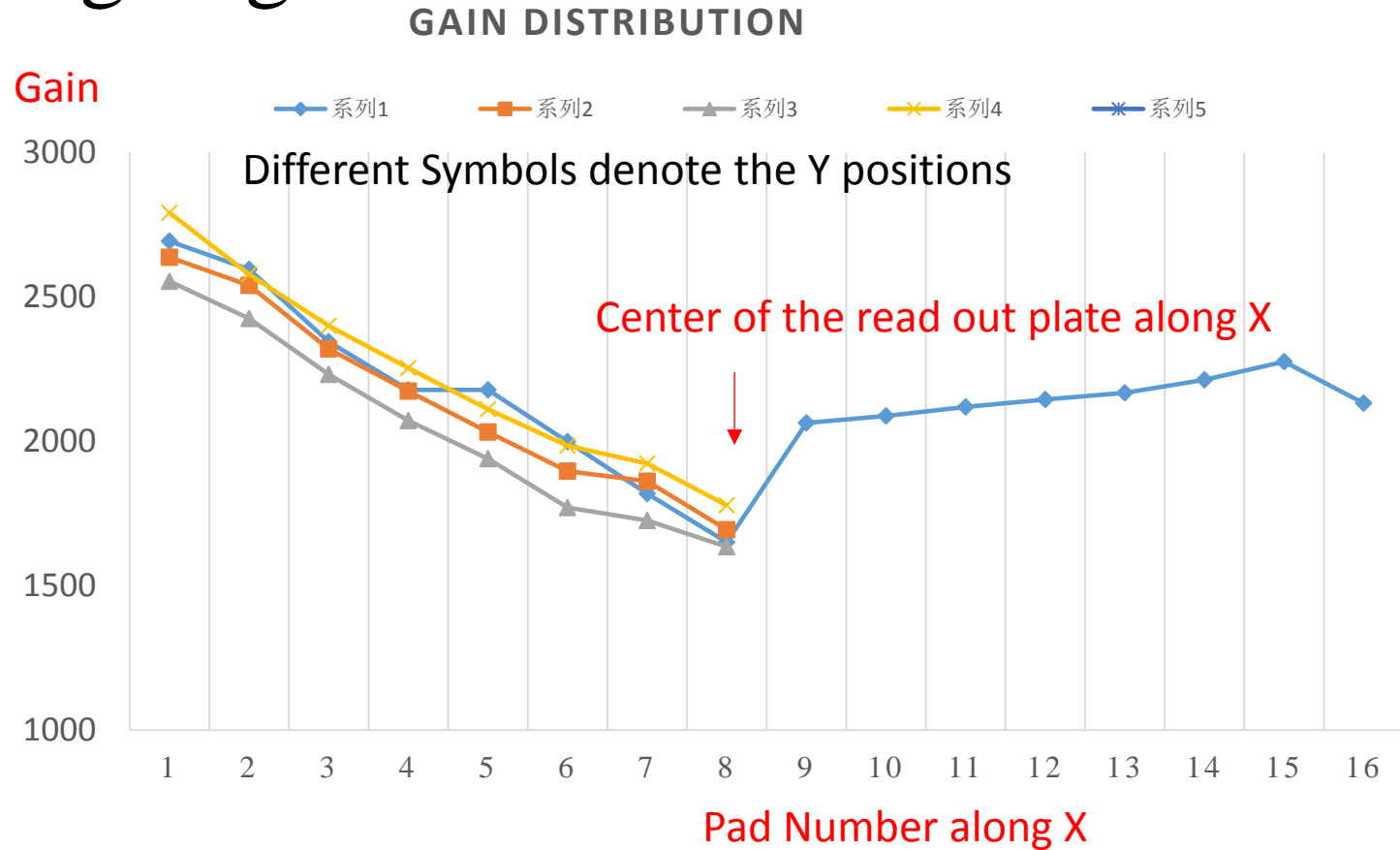
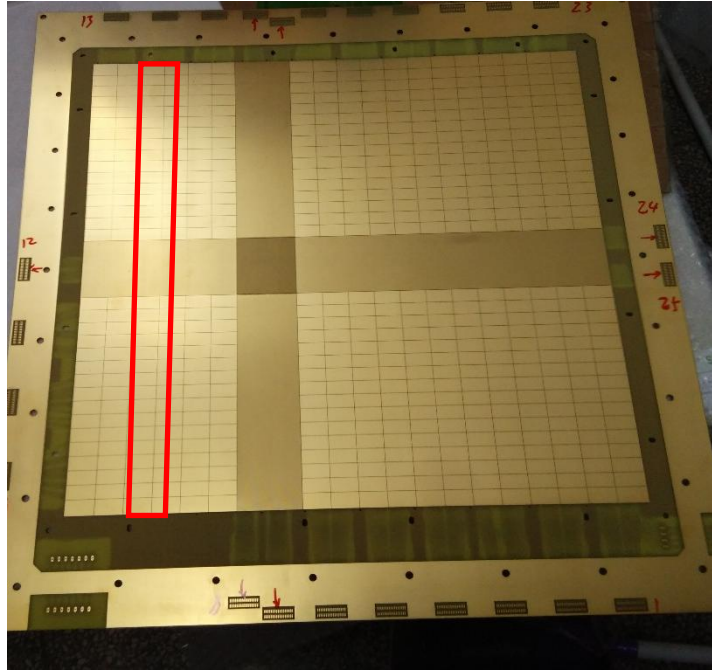

If manpower allows, will do the following test in near future

→ Complete the assembly of the larger GEM detector

→ To mount an array of calibrated MWPC telescope

→ Beam test of the Large GEM prototype using proton and pion beam in iHEP

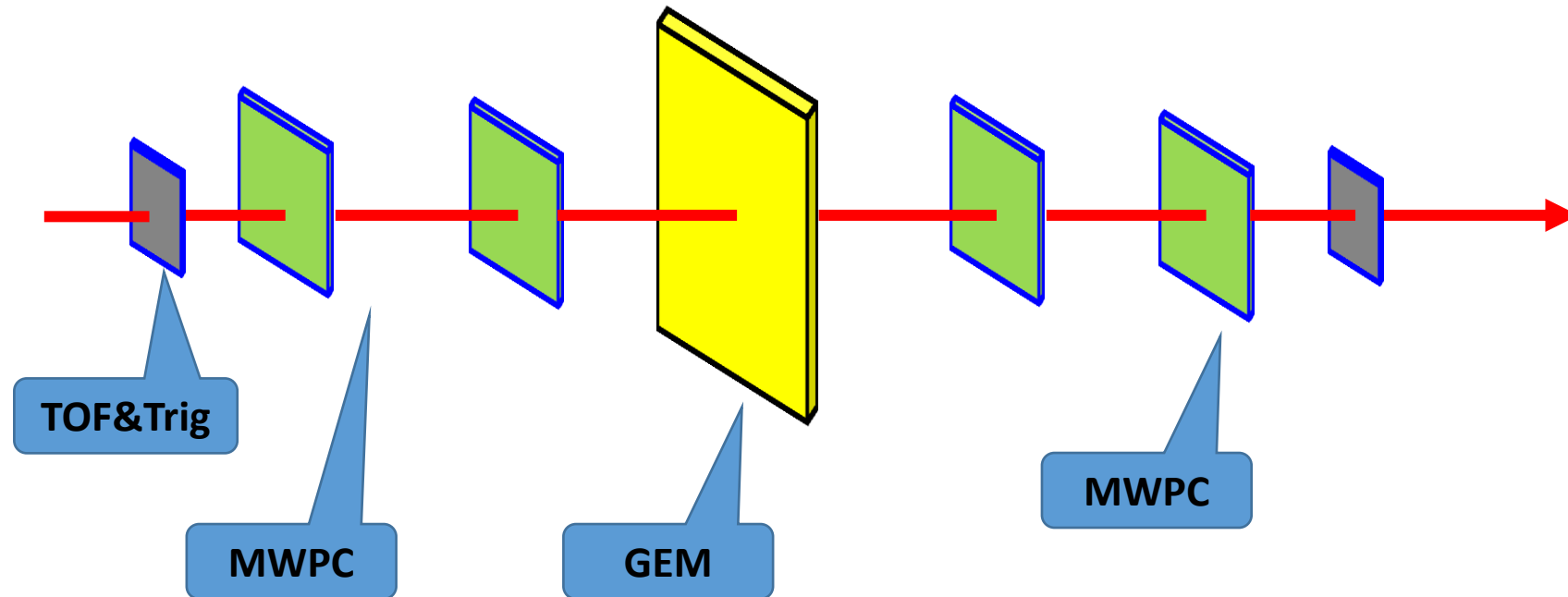

# pRad GEM in UVa

60 cm x 120 cm active area triple GEM chamber with 2D readout for Jefferson lab pRad experiment.

Collaborate with Prof. Liyanage's group (Kondo Gnanvo, Huong Nguyen and Xinzhan Bai) at UVA



The raw foil (from CERN)

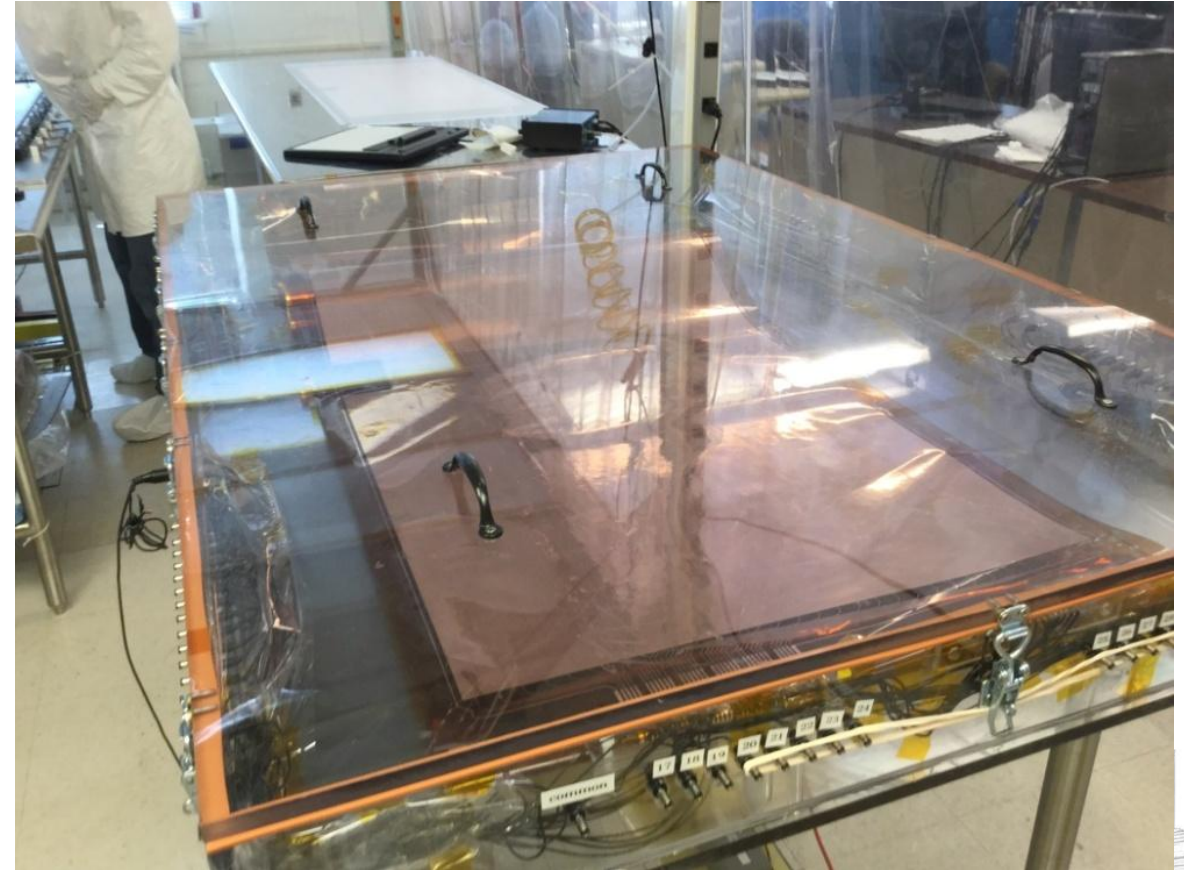

HV test of the raw foil



# The build of pRad GEM in UVa

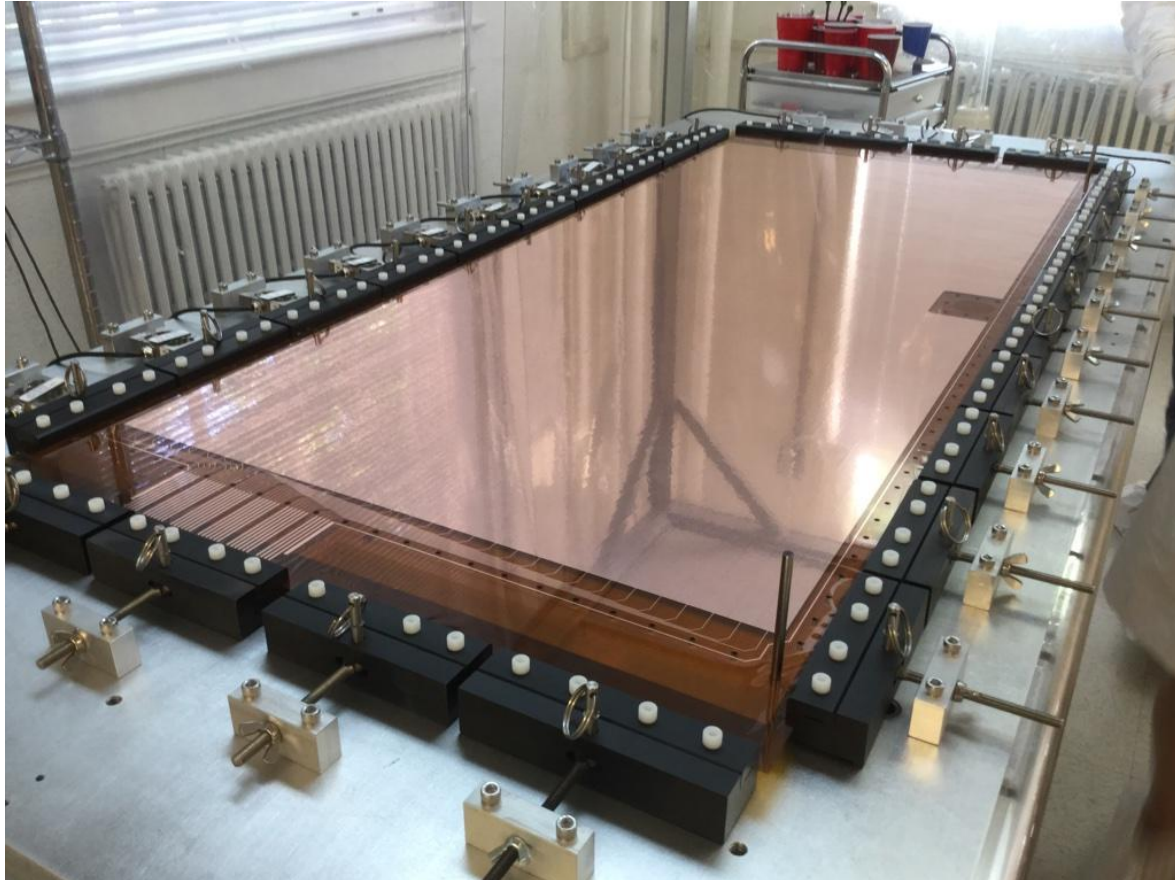

**Stretching the foil**

**Tension is approximately 0.3Kg/cm**

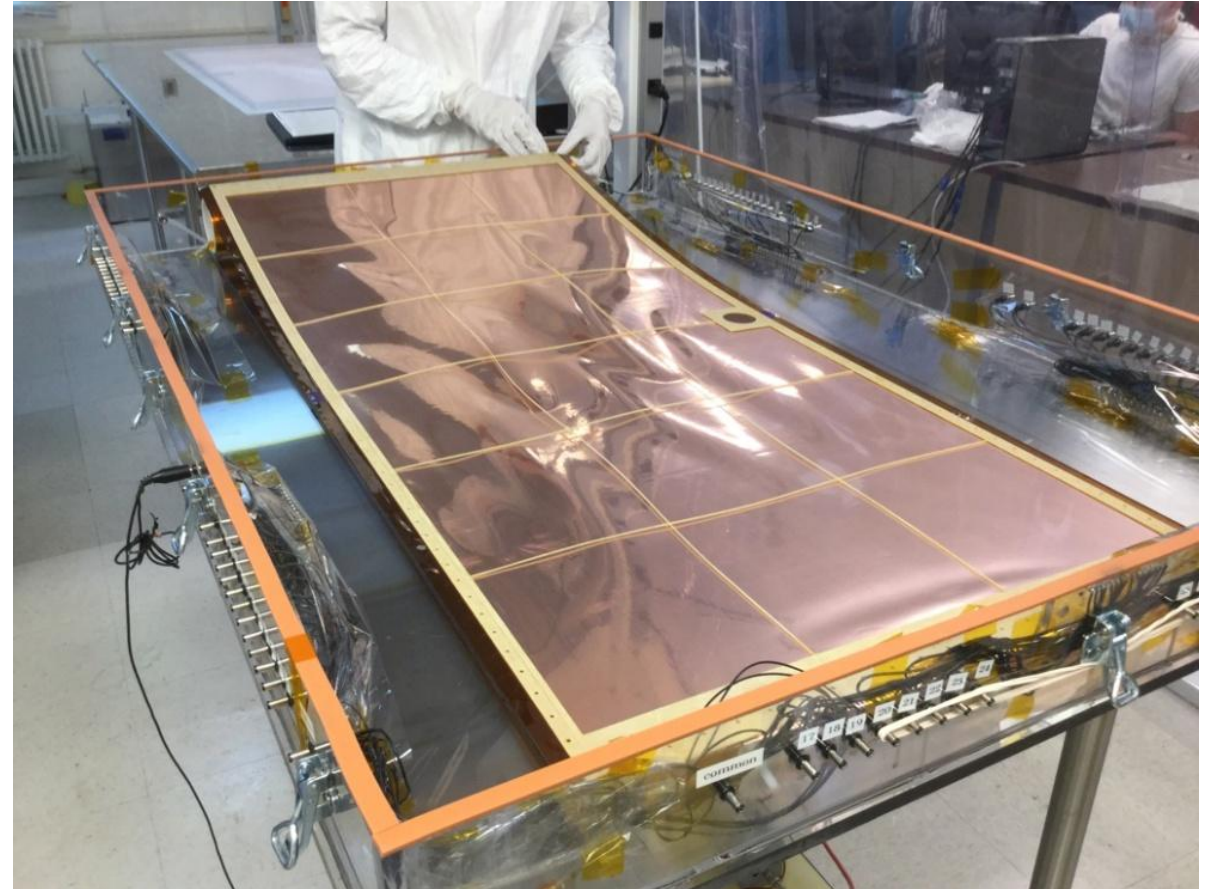

**HV test of framed foil in dry N2 box to check whether each sector is good: Put each sector to 550 V, and monitor the current for 2 minutes with picoammeter. The acceptance criterion is < 5 nA per sector.**





# The build of pRad GEM in UVa

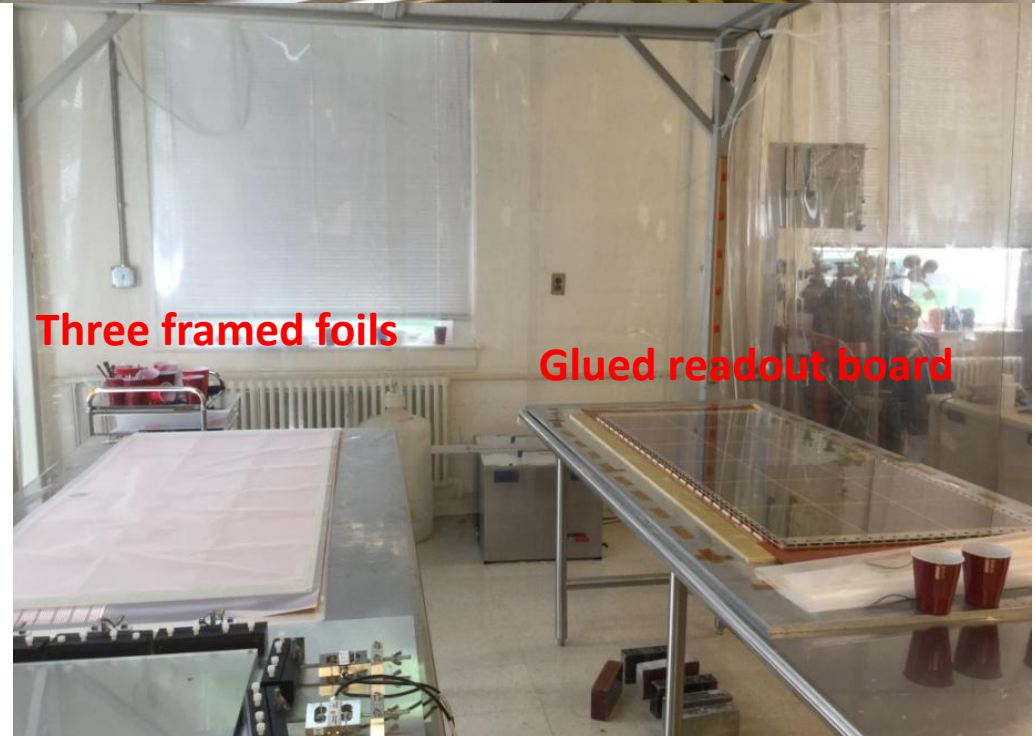
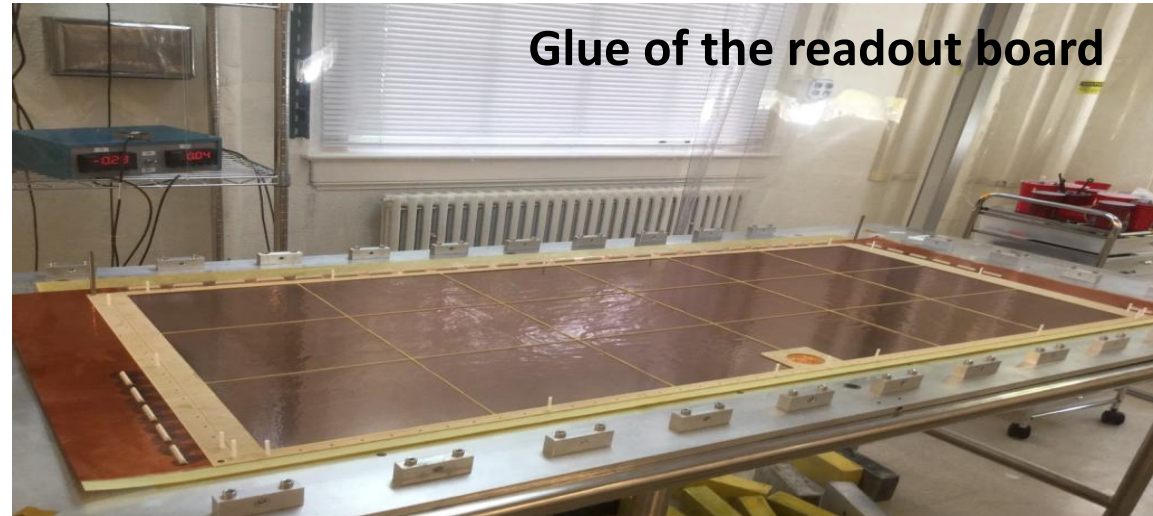
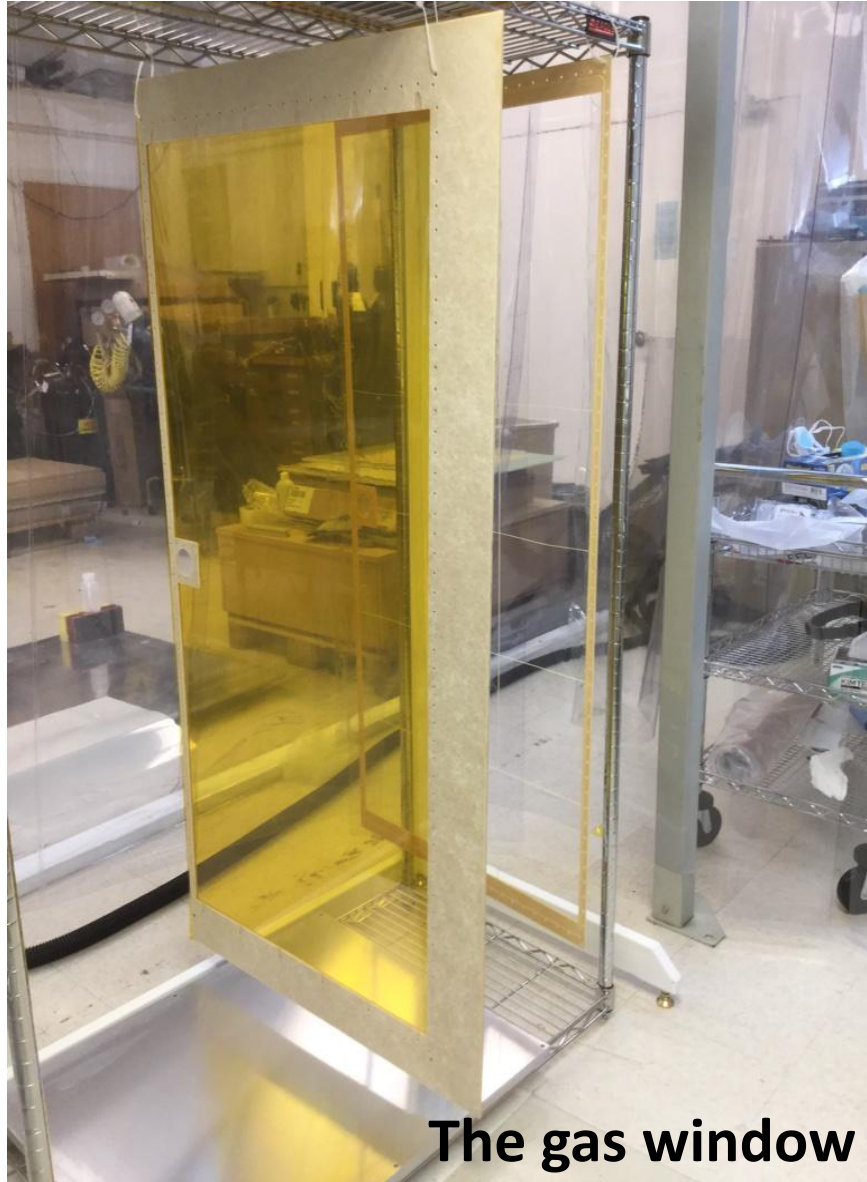

# Assembly of the pRad GEM

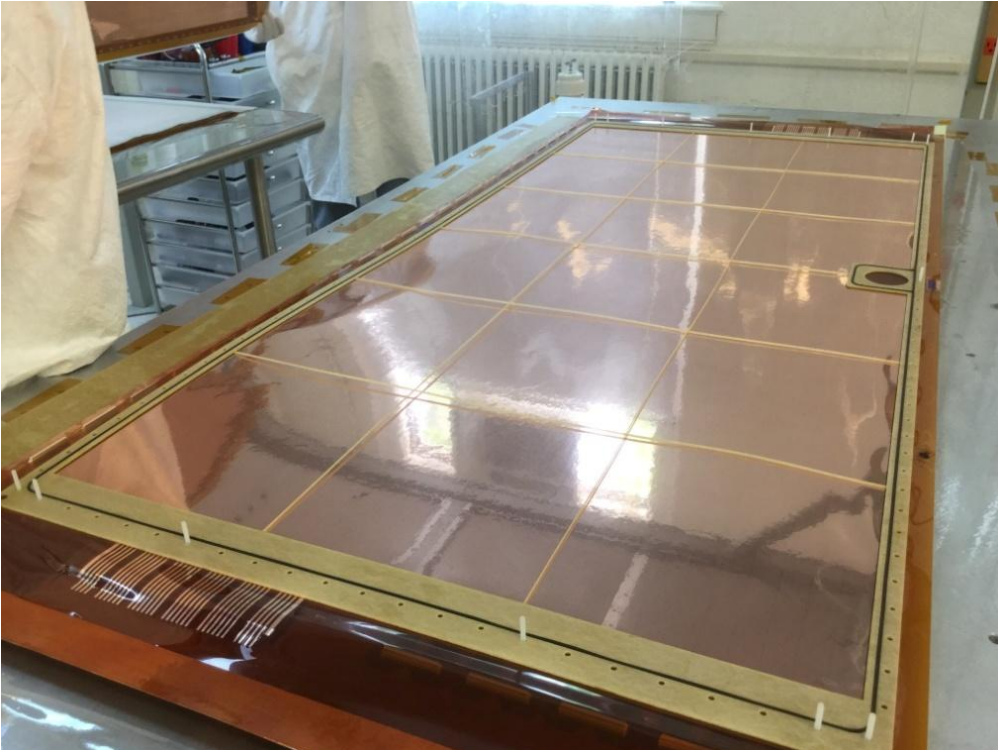

- The frames are bolted together with o-rings for gas seals: makes it possible to open the chamber for repairs if needed.
- The hole shown in the frames is for the beam passage

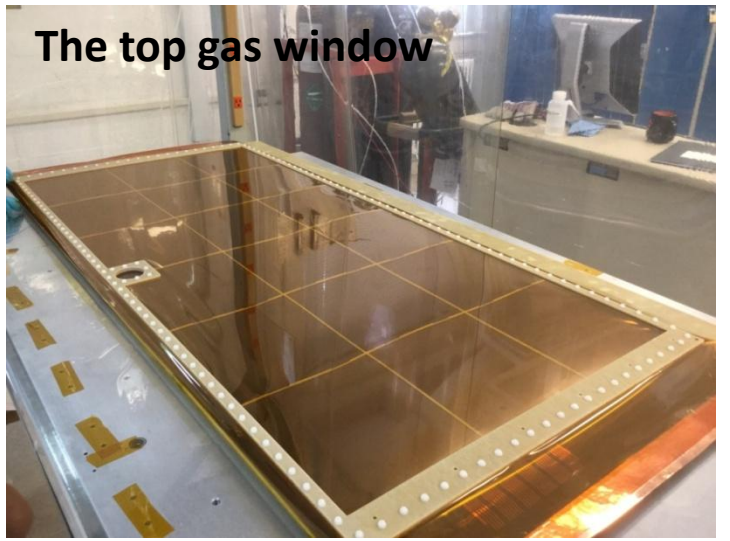

The top gas window

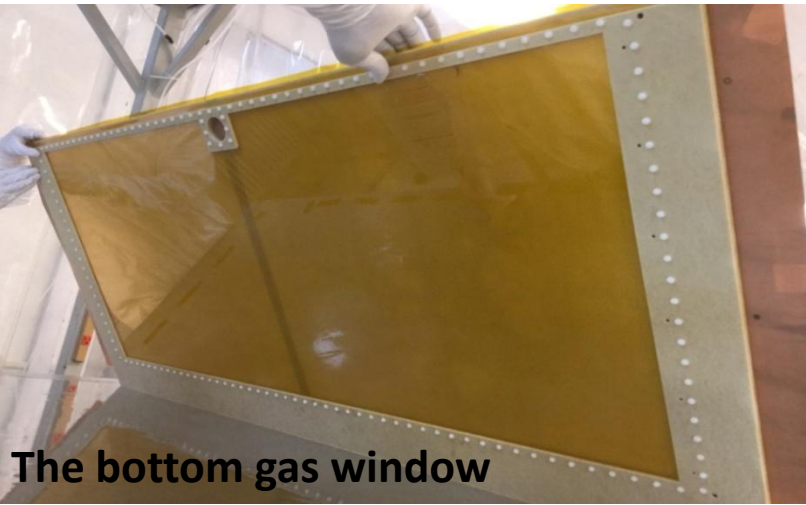

The bottom gas window

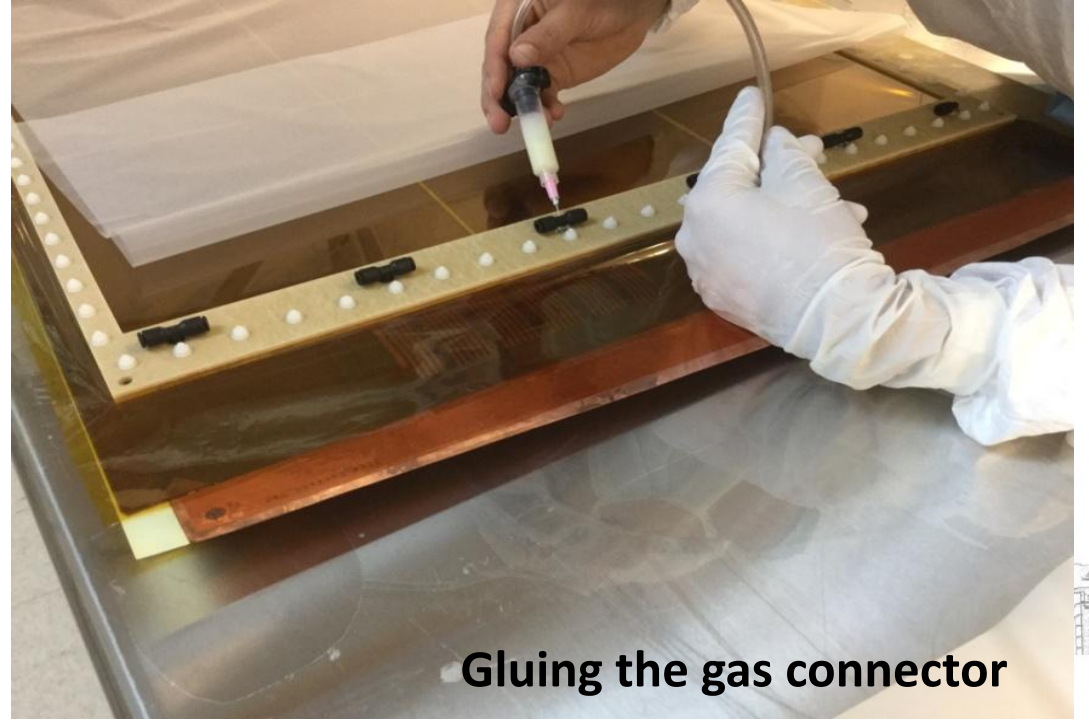

Gluing the gas connector

# Test of the pRad GEM detector

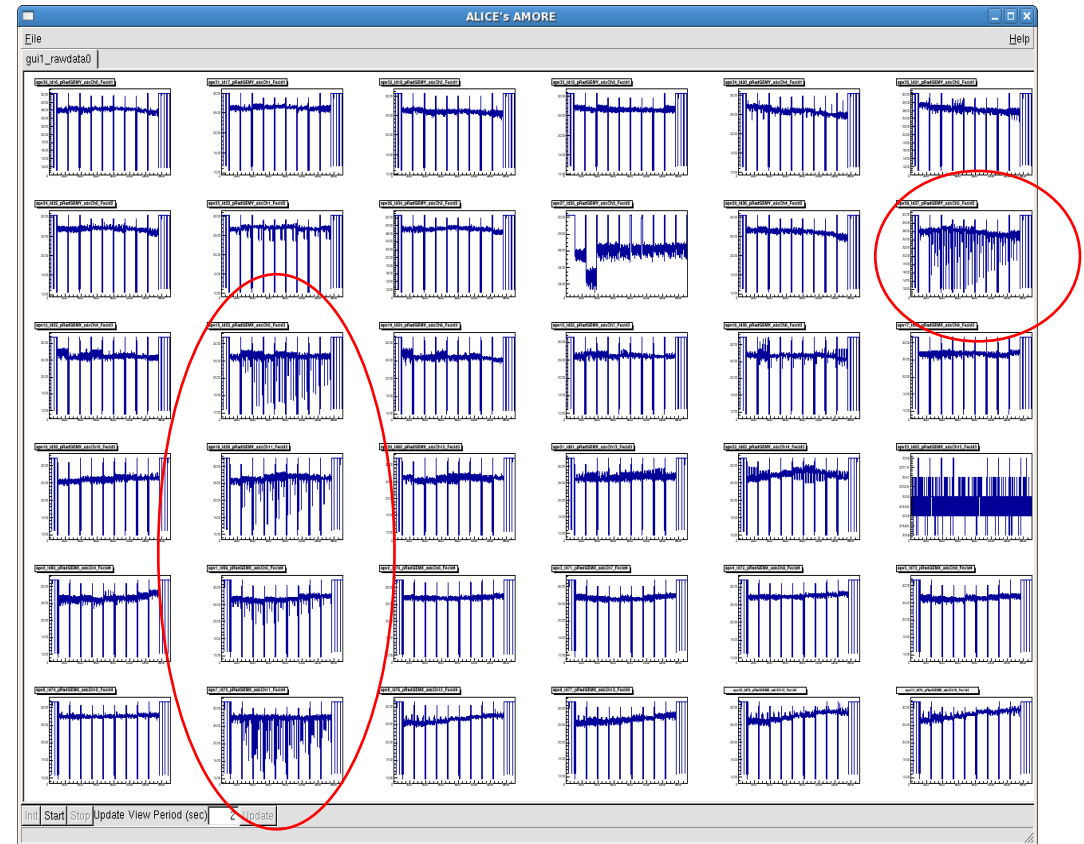
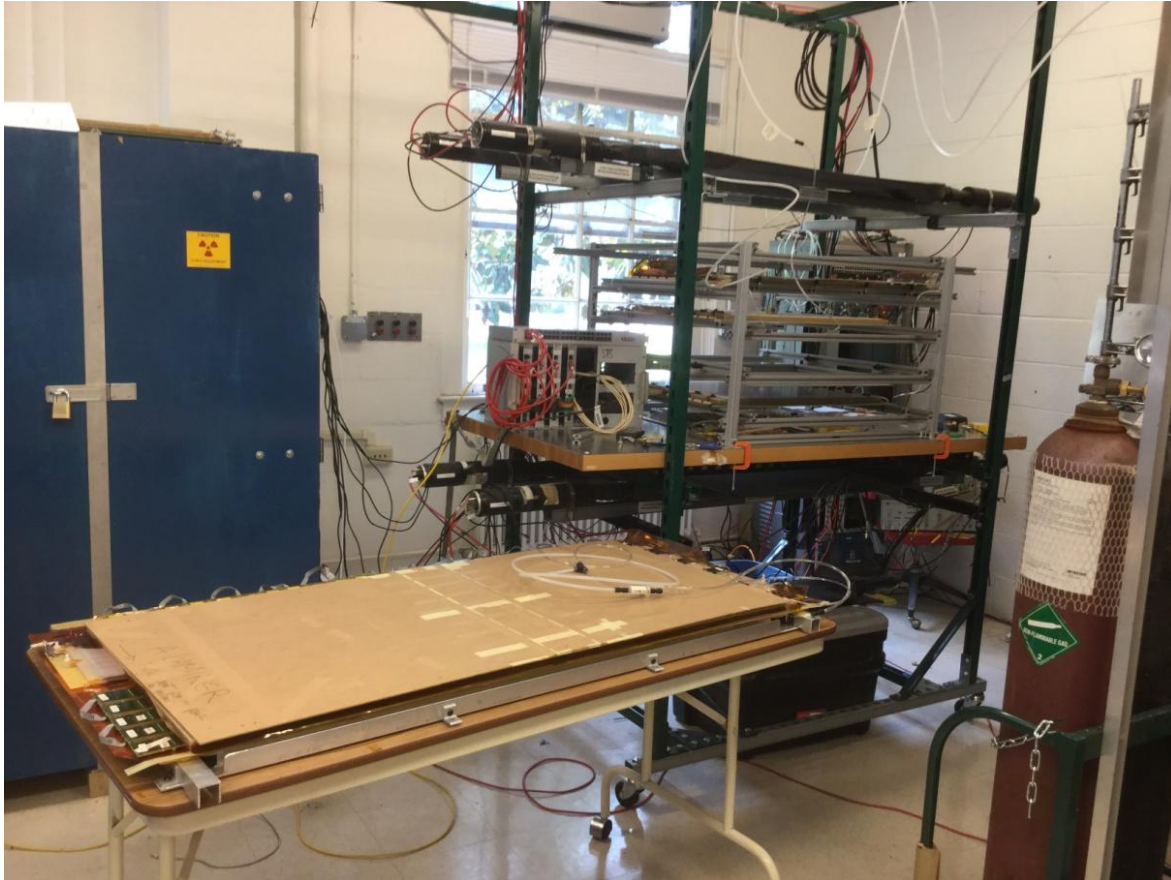

- Non-uniformity effect of the inter-foil distance is studied. The correspondence between the foil gap change and the gain change can be used to evaluate the non-uniformity of a large GEM detector.
- A large area GEM detector (450mm\*450mm) is assembled with 2 layers of GEM foil; Typical Energy Resolution is achieved, while the non-uniformity is still presented. Systematic non-uniformity is observed.
- The pRad GEM detector is built and works well.





**Thank you!**

# Backup

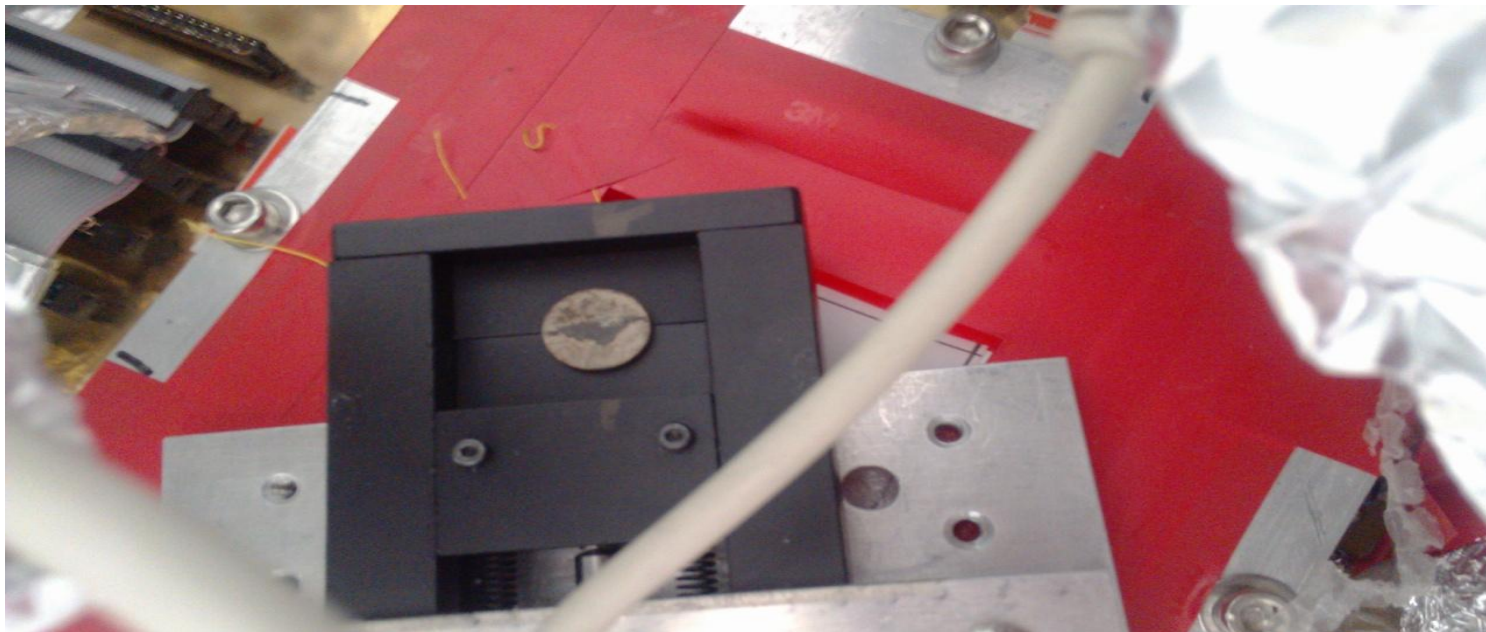

The slit is used as a collimator

## Spatial resolution method description

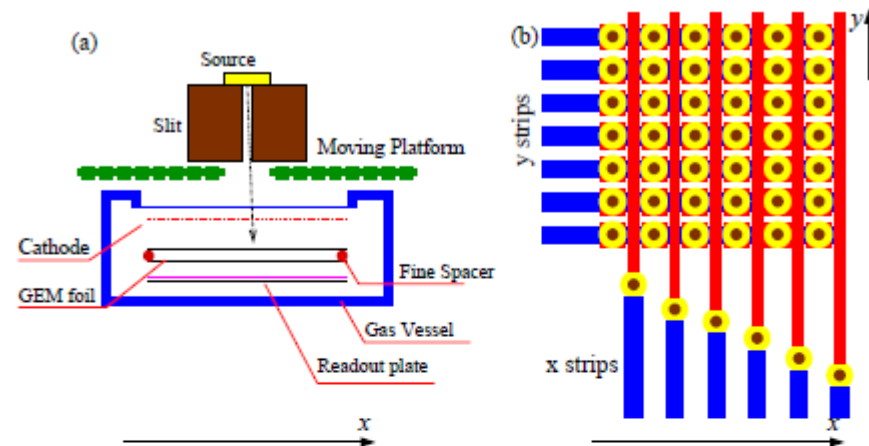
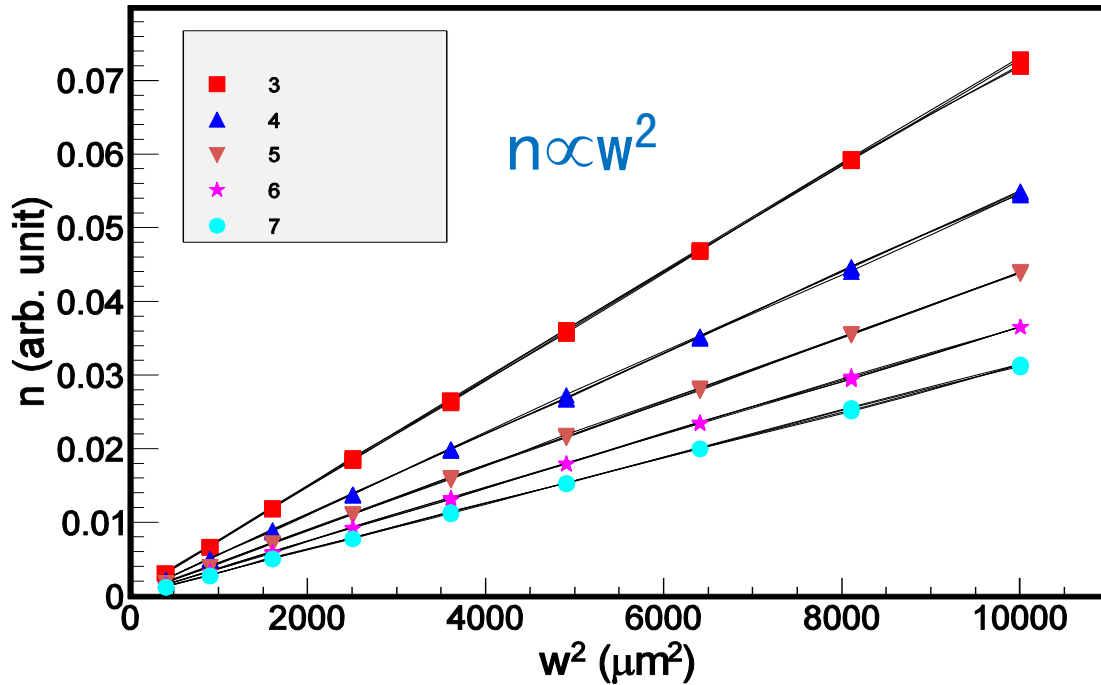

Fig. 1. (Color online) Schematic view of the experimental setup (a) and the pattern of the read-out strips in part (b). The slit is mounted on a precisely movable platform moving along x axis. The spacers between the GEM foils can be finely adjusted to introduce non-uniform gap thickness along x axis. The strip-to-strip distance of x (y) strips is 446 (625)  $\mu\text{m}$ . The strip width is 125 (345)  $\mu\text{m}$  for x (y) strips. The radius of the holes is 150  $\mu\text{m}$ . The components are shown not to scale for a clearer display.



## Spatial resolution method description

$$\sigma_{tot}^2 = \sigma_{GEM}^2 + c_1 \sigma_{Geometry}^2$$

when  $w \sim \sigma_{GEM}$

$$\sigma_{Geometry} = c_2 w$$

$$\sigma_{tot}^2 = \sigma_{GEM}^2 + c_0 w^2$$

$$n = \rho w \phi \Omega \eta / 4\pi$$

$$n = c_2 w^2 \quad \text{n is counting rate}$$

$$\sigma_{tot}^2 = \sigma_{GEM}^2 + c_0 n$$

NIM A701(2013)54 – 57



- Focus on fabrication of large-area GEM chambers using NS2 GEM stretching technique developed at CERN.
- Attractive advantages of NS2 stretching technique: free of gluing, fast chamber assembling, easy to reopen GEM chambers and replace components.
- Key aspects in GEM chamber design with NS2

- Screws
- Main frame
- GEM foil frames

